

User Manual

EVO 5 / EVO 10 SERIES

In order to prevent improper operation before use, please carefully read this manual.

Contents

1. Notes on This Manual	1
1.1 Scope of Validity	1
1.2 Target Group	1
1.3 Symbols Used	1
2. Safety	3
2.1 Handling of the Unit	3
2.2 Appropriate Usage of the Unit	3
2.3 PE Connection and Leakage Current	4
2.4 Response to Emergency Situations	5
2.5 Fire Protection Function	5
2.6 Warm up Function	6
2.7 Surge Protection Devices (SPDs) for PV Installation	7
3. Introduction	8
3.1 Basic Features	8
3.2 Dimensions (mm)	9
3.3 Terminals	10
4. Technical Data	11
4.1 PV Input	11
4.2 Battery	13
4.3 AC Input and Output (Grid)	15
4.4 EPS Output	17
4.5 Efficiency and Protection	19
4.6 General Data	21
5. Installation	22
5.1 Check for Physical Damage	22
5.2 Packing List	22
5.3 Mounting	23
6. Electrical Connection	32
6.1 Topological Diagram	32
6.2 Earth Connection	32
6.3 PV Connection	33
6.4 Grid Connection	35
6.5 CT / Meter Connection	38
6.6 Communication Interfaces	39
6.7 EPS Wiring (Non-parallel State)	44
6.8 System Start-up and Shutdown	45
6.9 System Black Start	46
7. Main Function Implementation	47
7.1 Parallel system wiring and setting	47
8. Firmware Upgrading	54
9. Operation	55
9.1 Control Panel	55

9.2 Function Tree	56
10. Maintenance	58
10.1 Alarm List.....	58
10.2 Troubleshooting and Routine Maintenance	64
11. Decommissioning	66
11.1 Dismantling	66
11.2 Packaging	66
11.3 Storage and Transportation	66

1. Notes on This Manual

1.1 Scope of Validity

This manual describes the assembly, installation, commissioning, maintenance and troubleshooting of the following model(s) of products.

EVO 10 series:

EVO 10-3.7-H	EVO 10-5-H	EVO 10-6-H	EVO 10-7-H	EVO 10-8-H
EVO 10-9-H	EVO 10-10-H	EVO 10-5-H-L	EVO 10-6-H-L	EVO 10-7.5-H-L
EVO 10-9.9-H-L				
EVO 10-3.7-AC	EVO 10-5-AC	EVO 10-6-AC	EVO 10-7-AC	EVO 10-8-AC
EVO 10-9-AC	EVO 10-10-AC	EVO 10-5-AC-L	EVO 10-6-AC-L	EVO 10-7.5-AC-L
EVO10-9.9-AC-L				

EVO 5 series:

EVO 5-3.7-H	EVO 5-5-H	EVO 5-6-H	EVO 5-7-H	EVO 5-8-H
EVO 5-9-H	EVO 5-10-H	EVO 5-5-H-L	EVO 5-6-H-L	EVO 5-7.5-H-L
EVO 5-9.9-H-L				
EVO 5-3.7-AC	EVO 5-5-AC	EVO 5-5-AC-L		



Note: Please keep this manual where it will be accessible at all times.

1.2 Target Group













This manual is for qualified electricians. The tasks described in this manual only can be performed by qualified electricians.



1.3 Symbols Used

The following types of safety instructions and general information appear in this document as described below:

 DANGER
Danger! "Danger" indicates a hazardous situation which, if not avoided, will result in death or serious injury.
 WARNING
Warning! "Warning" indicates a hazardous situation which, if not avoided, could result in death or serious injury.
 CAUTION
Caution! "Caution" indicates a hazardous situation which, if not avoided, could result in minor or moderate injury.
NOTE
Note! "Note" provides important tips and guidance.

This section explains the symbols shown on the unit and on the label:

Symbols	Explanation
	Symbol Explanation CE mark. The product complies with the requirements of the applicable CE guidelines.
	RCM mark.
	Danger of high voltages. Danger to life due to high voltages in the unit! Caution, risk of electric shock.
	Danger to life due to high voltage. There is residual voltage in the unit which needs 15 min to discharge. Wait 15 min before you open the upper lid or the DC lid. Caution, risk of electric shock, energy storage timed discharge.
	Read the instruction manual before starting installation and operation.
	The product should not be disposed as household wastes. Do not dispose of the product with household wastes.
	PE conductor terminal
	Do not place nor install near flammable or explosive materials.
	Install the product out of reach of children.
	Disconnect the equipment before carrying out maintenance or repair.
	Observe precautions for handling electrostatic discharge sensitive devices.
	Prohibit the use of water to extinguish fires.

	Prohibition of private maintenance.
	Prohibit connector reversal.

2. Safety

2.1 Handling of the Unit

Any work on the unit should be handled by authorized technicians. Technicians must familiarize themselves with this manual before maintenance or installation.

- Do not expose the unit to open flame.
- Do not place the system under direct sunlight.
- Do not place the unit near flammable materials (fire/explosion risk).
- Store the unit in a cool, dry place with good ventilation.
- Do not store the unit near water sources.
- Store the unit on a flat surface.
- Keep the unit out of reach of children and animals.
- Do not damage the enclosure by dropping, deforming, impacting, cutting or penetrating.
- Do not touch leaked liquid exuding from the unit (electric shock/skin damage risk).
- Always handle the power station wearing insulated gloves.
- Do not step on the unit or place foreign objects on it.
- Do not charge/discharge a damaged system or connect it to grid networks.
- Storage humidity must remain below 90%.

2.2 Appropriate Usage of the Unit

EVO series all-in-one units are designed and tested in accordance with international safety requirements. However, certain safety precautions must be taken when installing and operating the unit. The installer must read and follow all instructions, cautions and warnings in this manual.

- All operations including transport, installation, start-up and maintenance, must be carried out by qualified, trained personnel.
- The electrical installation & maintenance of the product shall be conducted by a licensed electrician and shall comply with local wiring rules and regulations.
- Before installation, check the unit to ensure it is free of any transport or handling damage, which could affect insulation integrity or safety clearances. Choose the installation location carefully and adhere to specified cooling requirements. Unauthorized removal of necessary protections, improper use, incorrect installation and operation may lead to serious safety and shock hazards or equipment damage.
- Before connecting the product to the power distribution grid, contact the local power distribution grid company to get appropriate approvals. This connection must be made only by qualified technical personnel.
- Do not install the product in adverse environmental conditions such as in close proximity to flammable or explosive substances; in a corrosive or desert environment; where there is exposure to extreme

high or low temperatures; or where humidity is high.

- Do not use the product when the safety devices do not work or are disabled.
- Use personal protective equipment, including gloves and eye protection during the installation.
- Inform the manufacturer about non-standard installation conditions.
- Do not use the product if any operating anomalies are found. Avoid temporary repairs.
- All repairs should be carried out using only approved spare parts, which must be installed in accordance with their intended use and by a licensed contractor or authorized service representative.
- Liabilities arising from commercial components are delegated to their respective manufacturers.
- Any time the product has been disconnected from the public network, please be extremely cautious as some components can retain charge sufficient to create a shock hazard. Prior to touching any part of the product please ensure surfaces and equipment are under touch safe temperatures and voltage potentials before proceeding.
- The product shall not be used in the hospital as medical equipment and can not function to sustain life.
- Ensure both the inverter and integrated system are completely powered off before installation.
- Do not interchange the positive and negative terminals of the power station.
- Verify no short circuits exist at terminals or with external devices.
- Ensure the entire unit is properly grounded.
- Do not attempt to disassemble the enclosure. Only Fox ESS is allowed to perform repairs.
- Use dry powder extinguisher exclusively for fire emergencies.
- Avoid high-static environments that may compromise system protections.
- Please confirm that the built-in battery pack in the newly installed All-in-one unit complies with the product warranty terms and has not been recharged within the past 5 months. Additionally, ensure the State of Charge (SOC) of the current battery system is maintained within $50\% \pm 5\%$.

2.3 PE Connection and Leakage Current

PV System Residual Current Factors

- In every PV installation, several elements contribute to the current leakage to protective earth (PE). these elements can be divided into two main types.
- Capacitive discharge current - Discharge current is generated mainly by the parasitic capacitance of the PV modules to PE. The module type, the environmental conditions (rain, humidity) and even the distance of the modules from the roof can effect the discharge current. Other factors that may contribute to the parasitic capacitance are the inverter's internal capacitance to PE and external protection elements such as lighting protection.
- During operation, the DC bus is connected to the alternating current grid via the inverter. Thus, a portion of the alternating voltage amplitude arrives at the DC bus. The fluctuating voltage constantly changes the charge state of the parasitic PV capacitor (i.e capacitance to PE). This is associated with a displacement current, which is proportional to the capacitance and the applied voltage amplitude.
- Residual current - if there is a fault, such as defective insulation, where an energized cable comes into contact with a grounded person, an additional current flows, known as a residual current.

Residual Current Device (RCMU)

- All inverters incorporate a certified internal RCMU (Residual current monitoring unit) to protect against possible electrocution in case of a malfunction of the PV array, cables or inverter (DC). The RCMU in the inverter can detect leakage on the DC side. There are 2 trip thresholds for the RCMU as required by the DIN VDE 0126-1-1 standard. A low threshold is used to protect against rapid changes in leakage typical of direct contact by people. A higher threshold is used for slowly rising leakage currents, to limit

the current in grounding conductors for the safety. The default value for higher speed personal protection is 30mA, and 300mA per unit for lower speed fire safety.

Installation and Selection of an External RCD device

- An external RCD is required in some countries. The installer must check which type of RCD is required by the specific local electric codes. Installation of an RCD must always be conducted in accordance with local codes and standards. It recommends the use of a type-A RCD. Unless a lower value is required by the specific local electric codes, it suggests an RCD value between 100mA and 300mA.
- In installations where the local electric code requires an RCD with a lower leakage setting, the discharge current might result in nuisance tripping of the external RCD. The following steps are recommended to avoid nuisance tripping of the external RCD:
- Selecting the appropriate RCD is important for correct operation of the installation. An RCD with a rating of 30mA may trip at a leakage as 15mA (according to IEC 61008). High quality RCDs will typically trip at a value closer to their rating.

2.4 Response to Emergency Situations

The batteries comprise of multiple batteries connected in series. It is designed to prevent hazards or failures. However, it cannot guarantee their absolute safety.

Under exposure to the internal materials of the battery the following recommendations should be carried out by the user.

1. If there has been inhalation, please leave the contaminated area immediately and seek medical attention.
2. If there has been contact with eyes, rinse the eyes with running water for 15 minutes and seek medical attention immediately.
3. If there has been contact with the skin, wash the contacted area with soap thoroughly and seek medical attention immediately.
4. If there has been ingestion, induce vomiting and seek medical attention.

• Fire Situation

In situations where the battery is on fire, if it is safe to do so, disconnect the battery pack by turn off the circuit breaker to shut off the power to the system. Use FM-200 or Co2 fire extinguisher for the battery and an ABC fire extinguisher for the other parts of the system.

Under any fire situation, please evacuate the people from the building immediately before trying to extinguish it.

• Water Situation

The battery modules are not water resistant. Hence care should be taken not to get it wet. If you find the battery completely or partially submerged in water do not try to open. Contact authorized personnel for further instructions.

2.5 Fire Protection Function

Despite the extremely stable chemical properties of lithium iron phosphate batteries and the multiple protections, each battery unit is equipped with a fire protection module to further ensure the safety and reliability of Fox ESS batteries. This innovative module utilizes a new type of aerosol fire extinguishing device with features such as pressure-free storage, no maintenance required, high extinguishing efficiency, non-toxic and harmless characteristics.

Fire Extinguishing Mechanism

The fire extinguishing mechanisms of common agents mainly include isolation, smothering, cooling, and chemical suppression, with different agents exhibiting varying mechanisms. The fire extinguishing

mechanism of thermal aerosols involves two main mechanisms: the cooling effect from endothermic decomposition and the chemical suppression effects in both gas and solid phases, which work synergistically. Additionally, the gaseous components in the products of the aerosol extinguishing agent also play a supportive role.

Cooling Fire Extinguishing Effect from Endothermic Decomposition

The cooling effect of thermal aerosol extinguishing agents is primarily due to the endothermic decomposition of metal oxides and carbonates. When a fire occurs, the solid particles in the aerosol rapidly absorb heat from the fire source, resulting in a decrease in flame temperature. This reduction minimizes the heat radiating to the burning surface and lowers the energy required to dissociate vaporized combustible materials into free radicals. As a result, the combustion reaction is effectively suppressed.

Gas Phase Chemical Suppression Effect

Under thermal conditions, vaporized metal ions, such as strontium (Sr), potassium (K), and magnesium (Mg), exist as vapors and participate in multiple chain reactions with active combustion radicals, including hydrogen (H•), hydroxyl (•OH), and oxygen (O•). For example:

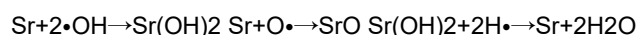

Through continuous action, this process consumes active combustion groups, significantly reducing their concentration and effectively suppressing combustion.

Solid Phase Chemical Suppression Effect

The solid particles in thermal aerosol extinguishing agents can adsorb intermediates such as •OH, H• and O• from chain reactions, catalyzing their recombination into stable molecules. This interrupts the essential branching chain reactions in the combustible process. For example:

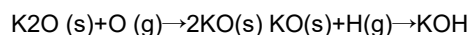

Note:

- (1) Please contact Fox ESS for immediate replacement if the fire protection module is activated.
- (2) Non-professionals should not disassemble the battery without authorization.
- (3) Do not touch the device until the casing has cooled after the internal fire extinguisher has been activated, to prevent it from burning.
- (4) For further assistance, please contact an authorized personnel or Fox ESS for further instructions.

2.6 Warm up Function

In low-temperature climates at high altitudes or latitudes, particularly during winter, the charging and discharging performance of batteries can significantly decline due to cold temperatures. To address this problem, Fox ESS has introduced a “Battery Heating” feature, enabling the battery system to operate effectively at extremely low temperature. This feature is exclusively available in the heated versions.

During Full Heating Period

When the battery temperature is between $-25^\circ\text{C} \sim 0^\circ\text{C}$, the system will heat the battery to 5°C . Heating will stop once this temperature is reached, but if the battery temperature falls below 0°C again, the heating system will reactivate.

The heating system prioritizes energy from the photovoltaic (PV) system. If PV power is insufficient, it will draw energy from either the battery or the grid, depending on the state of charge (SOC) of the battery:

- If the battery SOC > 40%, energy will be drawn from the battery, following the priority order:

PV > Battery > Grid.

- If the battery SOC < 40%, energy will be sourced from the grid, with the following priority order:
PV > Grid > Battery.

During PV Heating Period

The battery will only be heated when surplus energy is available from the PV system.

The complete heating function is turned off by default and must be manually enabled via the web interface or app when required. After activation, the heating periods must be configured as follows:

- heating period 1: start time 0:00, end time 0:00

- heating period 2: start time 0:00, end time 0:00

- heating period 3: start time 0:00, end time 0:00

The three time segments may overlap but cannot be mutually exclusive. Any time outside these segments will utilize PV energy only for heating.

Note:

(1) When the unit is not equipped with warm up function or the warm up function is not activated, the battery can only discharge when the battery temperature is above -20°C. For the battery designated as IFpR65/155[64S]M/-20+50/95 [202D] and IFpR65/155[32S]M/-20+50/95 [202D], the charging temperature support range is above -20°C; for the battery designated as IFpR61/154[64S]M/-20+50/95 [902D] and IFpR61/154[32S]M/-20+50/95 [902D], the charging temperature support range is above -10°C. When the heating function is enabled, all models can operate at -25°C.

(2) Please ensure that the wiring is properly connected and that all batteries are the heated versions. Otherwise, the heating function will not work.

(3) Heating control is based on the internal cell temperature of the battery, rather than the ambient temperature. Typically, the cell temperature will be higher than the ambient temperature under normal operating conditions.

For further assistance, please contact an authorized personnel or Fox ESS for further instructions.

* The all-in-one units include heating and non-heating versions. Please see the data plate on the unit for the presence of Warm up Function.

2.7 Surge Protection Devices (SPDs) for PV Installation

WARNING!

Over-voltage protection with surge arresters should be provided when the PV power system is installed.

The storage inverters are equipped with SPDs on the PV input side as standard, in order to meet the secondary lightning protection requirements.

3. Introduction

3.1 Basic Features

EVO series are high-quality all-in-one units which can convert solar energy to AC energy and store energy into battery. The unit can be used to optimize self-consumption, store in the battery for future use or feed-in to public grid. Work mode depends on PV energy and user's preference.

- System advantages:
 - Advanced DSP control technology.
 - Utilizes the latest high-efficiency power component.
 - Advanced anti-islanding solutions.
 - IP66 Ingress protection (for outdoor use) .
 - Max. Efficiency up to 99.9%; EU efficiency up to 97.2%; THD<3%.
 - Safety & Reliability: transformerless design with software and hardware protection.
 - Export limitation.
 - Power factor regulation.
 - Friendly HMI.
 - LED status indications.
 - LCD display technical data, human-machine interaction through four touch keys.
 - PC remote control.

- Work modes:

Work modes	Description
Self-use (with PV Power)	Priority: load>battery>grid The energy produced by the PV system is used to optimize self-consumption. The excess energy is used to charge the batteries, then exported to grid.
Self-use (without PV Power)	When no PV is supplied, the battery will discharge for local loads first. Battery will charge when excess generation from other generation sources is detected.
Feed in priority	Priority: load>grid>battery In the case of the external generator, the power generated will be used to supply the local loads firstly, then export to the public grid. The redundant power will charge the battery.

Back up mode	When the grid is off, system will supply emergency power from PV or battery to supply the home loads (Battery is necessary in EPS mode).
Peak Shaving	<p>The system can be set to provide a peak shaving function.</p> <p>A Peak Shaving limit must be set by adjusting "Import Limit" to the desired value.</p> <p>We can increase the peak shaving support uptime by setting the "Threshold SOC".</p> <p>When the battery is above the "Threshold SOC" the system will work in "Self-Use mode. When the battery is below the "Threshold SOC" the peak shaving function will be the priority and the system will only provide power from the battery when the "Import Limit" is exceeded. When below the "Threshold SOC" the system will charge from the grid when there is available power without exceeding the "Import Limit".</p> <p>This is to ensure prolonged Peak Shaving support for extended periods.</p> <p>If the "Import Limit" is exceeded constantly for an extended period of time, the peak shaving function can only guarantee successful operation while energy remains within the battery. If the battery designated "low level" is reached, the peak shaving function will cease.</p>

NOTE

Charging time is when the battery is charged within the set time range. The setting of charging time can be used in the above work modes. The charging period is mainly used to set the charging time from the power grid to the battery. The PV can also charge the battery when there is sufficient PV outside of charging time.

3.2 Dimensions (mm)

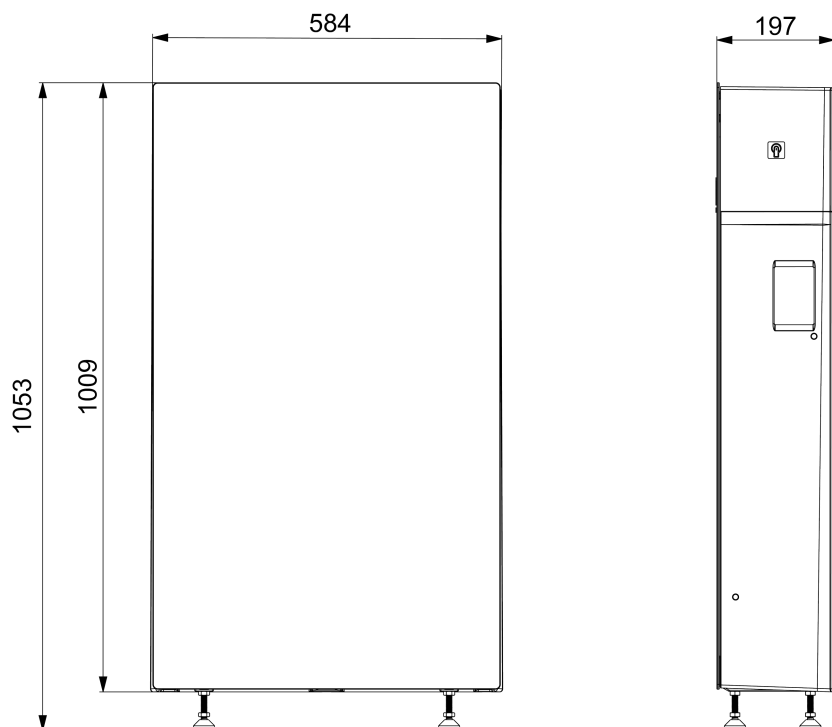

3.3 Terminals

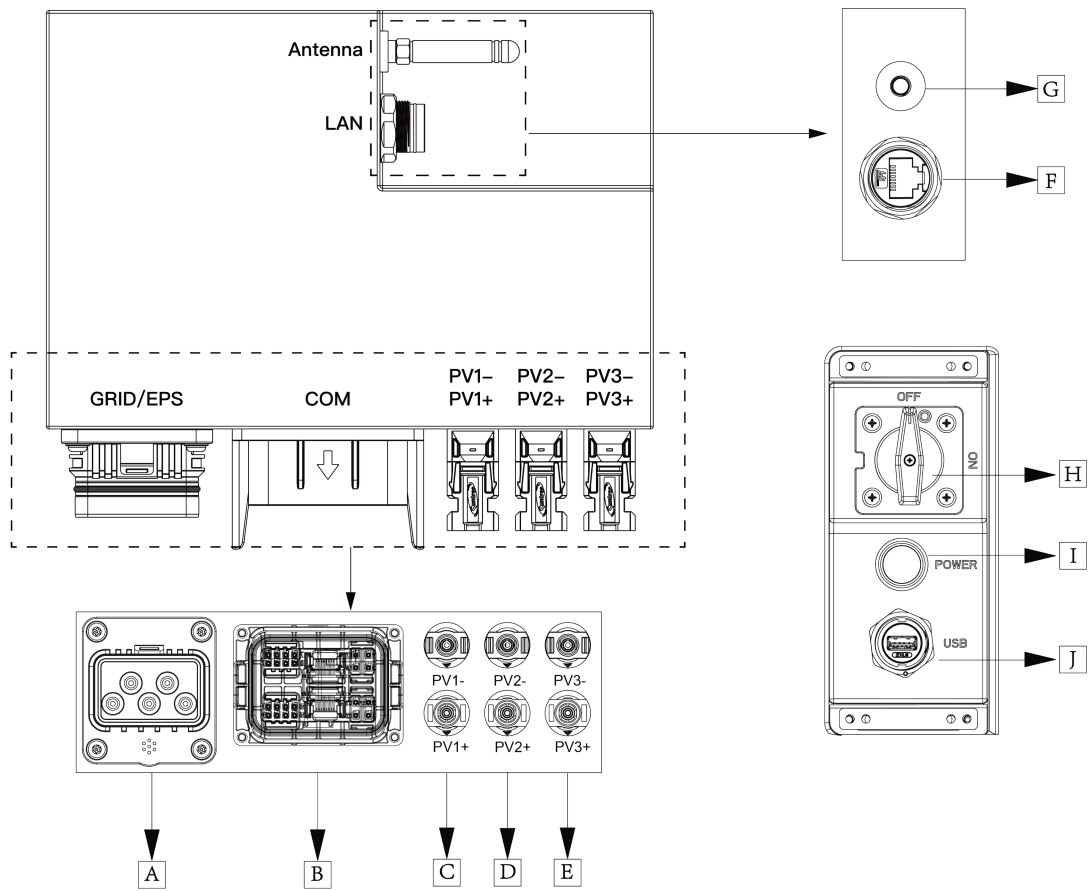

Item	Description	Item	Description
A	Grid & EPS port	F	LAN
B	Communication port	G	Antenna
C	PV1	H	DC switch
D	PV2	I	Power button@Black start
E	PV3	J	USB disk & Dongle

Note: Only authorized personnel are permitted to set the connection.

4. Technical Data

4.1 PV Input

For EVO 10 Series:

Model	EVO 10 -3.7-H	EVO 10 -5-H	EVO 10 -6-H	EVO 10 -7-H	EVO 10 -8-H	EVO 10 -9-H	EVO 10 -10-H	EVO 10 -5-H-L	EVO 10 -6-H-L	EVO 10 -7.5-H-L	EVO 10 -9.9-H-L
PV INPUT											
Max. PV array power [W]	16000	16000	16000	20000	20000	20000	20000	16000	16000	20000	20000
Max. input power [W]	13700	15000	16000	17000	18000	19000	20000	15000	16000	18000	20000
Max. MPPT input power [W]	8000/ 8000	8000/ 8000	8000/ 8000	8000/ 8000/ 8000	8000/ 8000/ 8000	8000/ 8000/ 8000	8000/ 8000/ 8000	8000/ 8000	8000/ 8000	8000/ 8000/ 8000	8000/ 8000/ 8000
Max. Input voltage [V]	600										
Min. input voltage [V]	75										
Start-up PV voltage [V]	80										
Nominal voltage [V]	360										
MPP voltage range [V]	80-550										
Max. PV input current [A]	20/20		20/20/20				20/20		20/20/20		
Max. Isc PV current [A]	25/25		25/25/25				25/25		25/25/25		
Strings per MPP tracker	1+1		1+1+1				1+1		1+1+1		
No. of MPP trackers	2		3				2		3		

For EVO 5 Series:

Models	EVO 5 -3.7-H	EVO 5 -5-H	EVO 5 -6-H	EVO 5 -7-H	EVO 5 -8-H	EVO 5 -9-H	EVO 5 -10-H	EVO 5 -5-H-L	EVO 5 -6-H-L	EVO 5 -7.5-H-L	EVO 5 -9.9-H-L
PV INPUT											
Max. PV array power [W]	16000	16000	16000	20000	20000	20000	20000	16000	16000	20000	20000
Max. input power [W]	8700	10000	11000	12000	13000	14000	15000	15000	16000	18000	20000
Max. MPPT input power [W]	8000/ 8000	8000/ 8000	8000/ 8000	8000/ 8000/ 8000	8000/ 8000/ 8000	8000/ 8000/ 8000	8000/ 8000/ 8000	8000/ 8000/ 8000	8000/ 8000	8000/ 8000/ 8000	8000/ 8000/ 8000
Max. Input voltage [V]	600										
Min. input voltage [V]	75										
Start-up PV voltage [V]	80										
Nominal voltage [V]	360										
MPP voltage range [V]	80-550										
Max. PV input current [A]	20/20		20/20/20				20/20		20/20/20		
Max. Isc PV current [A]	25/25		25/25/25				25/25		25/25/25		
Strings per MPP tracker	1+1		1+1+1				1+1		1+1+1		
No. of MPP trackers	2		3				2		3		

4.2 Battery

For EVO 10 Series:

Models	EVO 10 -3.7-H, EVO 10 -3.7-AC	EVO 10 -5-H, EVO 10 -5-AC	EVO 10 -6-H, EVO 10 -6-AC	EVO 10 -7-H, EVO 10 -7-AC	EVO 10 -8-H, EVO 10 -8-AC	EVO 10 -9-H, EVO 10 -9-AC	EVO 10 -10-H, EVO 10 -10-AC	EVO 10 -5-H-L, EVO 10 -5-AC-L	EVO 10 -6-H-L, EVO 10 -6-AC-L	EVO 10 -7.5-H-L, EVO 10 -7.5-AC-L	EVO 10 -9.9-H-L, EVO 10 -9.9-AC-L
BATTERY											
Battery type	LFP (LiFePO ₄)										
Battery designation	IFpR65/155[64S]M/-20+50/95 [202D] or IFpR61/154[64S]M/-20+50/95 [902D] (optional)										
Battery energy	10.24kWh										
Battery rated voltage [V]	204.8										
Battery voltage range [V]	185.6~233.6										
Max. battery charge power [W]	10000, 3680	10000, 5000	10000, 6000	10000, 7000	10000, 8000	10000, 9000	10000, 10000	10000, 5000	10000, 6000	10000, 7500	10000, 9900
Max. battery discharge power [W]	3680, 3680	5000, 5000	6000, 6000	7000, 7000	8000, 8000	9000, 9000	10000, 10000	5000, 5000	6000, 6000	7500, 7500	9900, 9900
Max. charge / discharge current [A]	50/18.4, 18.4/18.4	50/25, 25/25	50/30, 30/30	50/35, 35/35	50/40, 40/40	50/45, 45/45	50/50, 50/50	50/25, 25/25	50/30, 30/30	50/37.5, 37.5/37.5	50/49.5, 49.5/49.5
Max. continuous current [A]	50										
Depth of Discharge [%]	95%										
Scalability	NO										

For EVO 5 Series:

Models	EVO 5 -3.7-H, EVO 5 -3.7-AC	EVO 5 -5-H, EVO 5 -5-AC	EVO 5 -6-H	EVO 5 -7-H	EVO 5 -8-H	EVO 5 -9-H	EVO 5 -10-H	EVO 5 -5-H-L, EVO 5 -5-AC-L	EVO 5 -6-H-L	EVO 5 -7.5-H-L	EVO 5 -9.9-H-L	
BATTERY												
Battery type	LFP (LiFePO ₄)											
Battery designation	IFpR65/155[32S]M/-20+50/95 [202D] or IFpR61/154[32S]M/-20+50/95 [902D] (optional)											
Battery energy	5.12kWh											
Battery rated voltage [V]	102.4											
Battery voltage range [V]	92.8~116.8											
Max. battery charge power [W]	5000, 3680	5000, 5000	5000	5000	5000	5000	5000	5000	5000, 5000	5000	5000	5000
Max. battery discharge power [W]	3680, 3680	5000, 5000	5000	5000	5000	5000	5000	5000	5000, 5000	5000	5000	5000
Max. Charge / discharge current [A]	50/36.8, 18.4/18.4	50/50, 50/50	50/50	50/50	50/50	50/50	50/50	50/50	50/50, 50/50	50/50	50/50	50/50
Max. continuous current [A]	50											
Depth of Discharge [%]	95%											
Scalability	NO											

4.3 AC Input and Output (Grid)

For EVO 10 Series:

Models	EVO 10	EVO 10	EVO 10	EVO 10	EVO 10	EVO 10	EVO 10	EVO 10	EVO 10	EVO 10	EVO 10
	-3.7-H,	-5-H,	-6-H,	-7-H,	-8-H,	-9-H,	-10-H,	-5-H-L,	-6-H-L,	-7.5-H-L,	-9.9-H-L,
	EVO 10	EVO 10	EVO 10	EVO 10	EVO 10	EVO 10	EVO 10	EVO 10	EVO 10	EVO 10	EVO 10
	-3.7-AC	-5-AC	-6-AC	-7-AC	-8-AC	-9-AC	-10-AC	-5-AC-L	-6-AC-L	-7.5-AC-L	-9.9-AC-L
AC OUTPUT											
Rated power [W]	3680	5000	6000	7000	8000	9000	10000	5000	6000	7500	9900
Rated apparent power [VA]	3680	5000	6000	7000	8000	9000	10000	5000	6000	7500	9900
Max. apparent power [VA] ^[1]	3680/ 3680 ^[1]	5500/ 5000 ^[1]	6600/ 6000 ^[1]	7700/ 7000 ^[1]	8800/ 8000 ^[1]	9900/ 9000 ^[1]	11000/ 10000 ^[1]	5000	6000	7500	9900
Nominal voltage [V]	220/230/240, L/N/PE										
Nominal frequency [Hz]	50/60Hz, ±5Hz										
Rated output current (Per phase) [A]	16.7	22.7	27.3	31.8	36.4	40.9	45.5	22.7	27.3	34.1	45.0
Max. AC current (Per phase) [A]	16.7	25.0	30.0	35.0	40.0	45.0	50.0	22.7	27.3	34.1	45.0
Power factor	1(Adjustable from 0.8 leading to 0.8 lagging)										
Inrush current [A]	15A@0.5ms										
Max. output fault current [A]	150A@0.5ms										
Max. output overcurrent protection [A]	147A										
THDI	<3%@rated power										
AC INPUT											
Max. apparent power [VA]	4400	6000	7200	8400	9600	10800	12000	6000	7200	9000	11880
Nominal voltage [V]	220/230/240, L/N/PE										
Nominal frequency [Hz]	50/60Hz, ±5Hz										
Max. input current [A] (Per Phase)	20.0	27.3	32.7	38.2	43.6	49.1	54.5	27.3	32.7	40.9	54.0
Power factor	1(Adjustable from 0.8 leading to 0.8 lagging)										
Inrush current [A]	15A@0.5ms										

[1]When Spanish regulations are selected, the Max. apparent power is limited to the rated power.

For EVO 5 Series:

Models	EVO 5 -3.7-H, EVO 5 -3.7-AC	EVO 5 -5-H, EVO 5 -5-AC	EVO 5 -6-H	EVO 5 -7-H	EVO 5 -8-H	EVO 5 -9-H	EVO 5 -10-H	EVO 5 -5-H-L, EVO 5 -5-AC-L	EVO 5 -6-H-L	EVO 5 -7.5-H-L	EVO 5 -9.9-H-L
AC OUTPUT											
Rated power [W]	3680	5000	6000	7000	8000	9000	10000	5000	6000	7500	9900
Rated apparent power [VA]	3680	5000	6000	7000	8000	9000	10000	5000	6000	7500	9900
Max. apparent power [VA] ^[1]	3680/ 3680 ^[1]	5500/ 5000 ^[1]	6600/ 6000 ^[1]	7700/ 7000 ^[1]	8800/ 8000 ^[1]	9900/ 9000 ^[1]	11000/ 10000 ^[1]	5000	6000	7500	9900
Nominal voltage [V]	220/230/240, L/N/PE										
Nominal frequency [Hz]	50/60Hz , ±5Hz										
Rated output current (Per phase) [A]	16.7	22.7	27.3	31.8	36.4	40.9	45.5	22.7	27.3	34.1	45.0
Max. AC current (Per phase) [A]	16.7	25.0	30.0	35.0	40.0	45.0	50.0	22.7	27.3	34.1	45.0
Power factor	1(Adjustable from 0.8 leading to 0.8 lagging)										
Inrush current [A]	15A@0.5ms										
Max. output fault current [A]	150A@0.5ms										
Max. output overcurrent protection [A]	147A										
THDI	<3%@rated power										
AC INPUT											
Max. apparent power [VA]	4400	6000	7200	8400	9600	10800	12000	6000	7200	9000	11880
Nominal voltage [V]	220/230/240, L/N/PE										
Nominal frequency [Hz]	50/60Hz, ±5Hz										
Max. input current [A] (Per Phase)	20.0	27.3	32.7	38.2	43.6	49.1	54.5	27.3	32.7	40.9	54.0
Power factor	1(Adjustable from 0.8 leading to 0.8 lagging)										
Inrush current [A]	15A@0.5ms										

[1]When Spanish regulations are selected, the Max. apparent power is limited to the rated power.

4.4 EPS Output

For EVO 10 Series:

Models	EVO 10	EVO 10	EVO 10	EVO 10	EVO 10	EVO 10	EVO 10	EVO 10	EVO 10	EVO 10	EVO 10
	-3.7-H,	-5-H,	-6-H,	-7-H,	-8-H,	-9-H,	-10-H,	-5-H-L,	-6-H-L,	-7.5-H-L,	-9.9-H-L,
	EVO 10	EVO 10	EVO 10	EVO 10	EVO 10	EVO 10	EVO 10	EVO 10	EVO 10	EVO 10	EVO 10
	-3.7-AC	-5-AC	-6-AC	-7-AC	-8-AC	-9-AC	-10-AC	-5-AC-L	-6-AC-L	-7.5-AC-L	-9.9-AC-L
EPS OUTPUT											
Max. apparent power [VA]	3680	5000	6000	7000	8000	9000	10000	5000	6000	7500	9900
Load Start Capability [A]	100A@2s										
Nominal voltage [V]	220/230/240, L/N/PE										
Nominal frequency [Hz]	50/60										
Max. output current (Per phase) [A]	16.7	22.7	27.3	31.8	36.4	40.9	45.5	22.7	27.3	34.1	45.0
Power factor	1(Adjustable)										
Switch time	<4ms										
THDV	<3%@Linear Load										
Parallel operation	Yes @max 3PCS										

For EVO 5 Series:

Models	EVO 5	EVO 5	EVO 5	EVO 5	EVO 5	EVO 5	EVO 5	EVO 5	EVO 5	EVO 5	EVO 5
	-3.7-H, EVO 5 -3.7-AC	-5-H, EVO 5 -5-AC	-6-H	-7-H	-8-H	-9-H	-10-H	-5-H-L, EVO 5 -5-AC-L	-6-H-L	-7.5-H-L	-9.9-H-L
EPS OUTPUT											
Max. apparent power [VA]	3680	5000	6000	7000	8000	9000	10000	5000	6000	7500	9900
Load Start Capability [A]	100A@2s										
Nominal voltage [V]	220/230/240, L/N/PE										
Nominal frequency [Hz]	50/60										
Max. output current (Per phase) [A]	16.7	22.7	27.3	31.8	36.4	40.9	45.5	22.7	27.3	34.1	45.0
Power factor	1(Adjustable)										
Switch time	<4ms										
THDV	<3%@Linear Load										
Parallel operation	Yes @max 3PCS										

4.5 Efficiency and Protection

For EVO 10 Series:

Models	EVO 10 -3.7-H, EVO 10 -3.7-AC	EVO 10 -5-H, EVO 10 -5-AC	EVO 10 -6-H, EVO 10 -6-AC	EVO 10 -7-H, EVO 10 -7-AC	EVO 10 -8-H, EVO 10 -8-AC	EVO 10 -9-H, EVO 10 -9-AC	EVO 10 -10-H, EVO 10 -10-AC	EVO 10 -5-H-L, EVO 10 -5-AC-L	EVO 10 -6-H-L, EVO 10 -6-AC-L	EVO 10 -7.5-H-L, EVO 10 -7.5-AC-L	EVO 10 -9.9-H-L, EVO 10 -9.9-AC-L
EFFICIENCY											
*Max. static MPPT efficiency	99.90%	99.90%	99.90%	99.90%	99.90%	99.90%	99.90%	99.90%	99.90%	99.90%	99.90%
*Max. conversion efficiency	97.60%	97.62%	97.62%	97.62%	97.62%	97.62%	97.62%	97.62%	97.62%	97.62%	97.62%
*European efficiency	97.16%	97.20%	97.20%	97.20%	97.20%	97.20%	97.20%	97.20%	97.20%	97.20%	97.20%
*Max. Battery charge efficiency (PV to BAT)(@full load)	97.33%	97.30%	97.30%	97.30%	97.30%	97.30%	97.30%	97.30%	97.30%	97.30%	97.30%
Max. Battery charge/discharge efficiency (BAT to AC)(@full load)	96.40%	96.40%	96.40%	96.40%	96.40%	96.40%	96.40%	96.40%	96.40%	96.40%	96.40%
PROTECTION											
*PV Reverse Polarity Protection PV	YES										
Anti-islanding Protection	YES										
Output Short Protection	YES										
Leakage Current Protection	YES										
Insulation resistance detection	YES										
Over-current protection	YES										
Over-temperature Protection	YES										
Earth fault	YES										
DC/AC Surge Protection	YES [Type II (PV)/Type II (AC)]										
AFCI Protection	YES										

Note: The technical data marked by “*” are only for hybrid products.

For EVO 5 Series:

Models	EVO 5	EVO 5	EVO 5	EVO 5	EVO 5	EVO 5	EVO 5	EVO 5	EVO 5	EVO 5	EVO 5
	-3.7-H, EVO 5 -3.7-AC	-5-H, EVO 5 -5-AC	-6-H	-7-H	-8-H	-9-H	-10-H	-5-H-L, EVO 5 -5-AC-L	-6-H-L	-7.5-H-L	-9.9-H-L
	EFFICIENCY										
*Max. static MPPT efficiency	99.90%	99.90%	99.90%	99.90%	99.90%	99.90%	99.90%	99.90%	99.90%	99.90%	99.90%
*Max. conversion efficiency	97.60%	97.62%	97.62%	97.62%	97.62%	97.62%	97.62%	97.62%	97.62%	97.62%	97.62%
*European efficiency	97.16%	97.20%	97.20%	97.20%	97.20%	97.20%	97.20%	97.20%	97.20%	97.20%	97.20%
*Max. Battery charge efficiency (PV to BAT)(@full load)	95.40%	95.40%	95.40%	95.40%	95.40%	95.40%	95.40%	95.40%	95.40%	95.40%	95.40%
Max. Battery charge/discharge efficiency (BAT to AC)(@full load)	94.50%	94.50%	94.50%	94.50%	94.50%	94.50%	94.50%	94.50%	94.50%	94.50%	94.50%
PROTECTION											
*PV Reverse Polarity Protection PV	YES										
Anti-islanding Protection	YES										
Output Short Protection	YES										
Leakage Current Protection	YES										
Insulation resistance detection	YES										
Over-current protection	YES										
Over-temperature Protection	YES										
Earth fault	YES										
DC/AC Surge Protection	YES [Type II (PV)/Type II (AC)]										
AFCI Protection	YES										

Note: The technical data marked by “*” are only for hybrid products.

4.6 General Data

General Data	
Dimension (W/H/D) [mm]	584*1009*197
Net weight [Kg]	115Kg (hybrid, [202D]); 112Kg (AC, [202D]) 109Kg (hybrid, [902D]); 106Kg (AC, [902D])
Installation	Floor-mounted / Wall-mounted
Operating temperature range [°C]	-20 to +55 °C (Derating at 45°C)
Storage temperature [°C]	0 ~35 °C
Storage/Operation Relative humidity	0%-100%
Altitude [m]	<4000m @Derating exceeding 2000m
Protective class	I
Overvoltage category	III(AC), II(DC)
Pollution degree	PD3 (PD2 inside)
Ingress protection	IP66 (For Outdoor Use)
Standby consumption [W]	<20W
AFCI function	Optional
Battery heating function	Optional
Cooling principle	Intelligent air cooling
Noise emission [dB]	<45dB Average
Inverter topology	Non-Isolated
Communication Interface	Ethernet, EMS(RS485), Meter, WiLAN(WiFi+LAN+Bluetooth), 4G(Optional), DRM, Ripple Control, USB, SG Ready
Display	LED/LCD/APP/website
Export limit control	YES
DC switch	YES
Button	Capacitive touch sensor * 4
Standard Compliance	
Safety (hybrid)	EN/IEC 62109-1, EN/IEC 62109-2, EN/IEC62477-1, EN/IEC 62040 (Australia)
Safety (AC)	EN/IEC62477-1, EN/IEC 62040 (Australia)
EMC	EN IEC 61000-6-1:2019, EN IEC 61000-6-3:2021, EN IEC 61000-6-2:2019, EN IEC 61000-6-4:2019, IEC 62920:2017
RED	EN 50665:2017, ENIEC 62311:2020, EN 301 489-1 V2.2.3 (2019-11), EN 301 489-17 V3.2.4 (2020-09), EN 300 328 V2.2.2(2019-07), EN 55032:2015+A11:2020+A1:2020, EN 55035:2017+A11:2020
Grid Regulation	G98, CEI 0-21, AS/NZS 4777.2:2020, NRS 097-2-1, IEC 61727, EN 50549-1, P140/P515
Battery Regulation	IEC62619:2022
Transportation	UN 38.3

*the RF OPERATING FREQUENCY (the maximum transmitted power)

Wifi 2.4GHz : 2412MHz~2472MHz 19 dBm

Bluetooth : 2402MHz~2480MHz 8 dBm

5. Installation

5.1 Check for Physical Damage

Make sure the unit is intact during transportation. If there is any visible damage, such as cracks, please contact your dealer immediately.

5.2 Packing List

Open the package and take out the product, please check the accessories first. The packing list shown as below.



Note:

For 5~6kW, the package includes 4 PV connectors and 4 PV pin contacts (2*positive, 2*negative);
For 7~10kW, the package includes 6 PV connectors and 6 PV pin contacts (3*positive, 3*negative).

5.3 Mounting

• Installation Precaution

Make sure the installation site meets the following conditions:

- Not in direct sunlight.
- Not in areas where highly flammable materials are stored, e.g. pressurized gas cylinders, natural gas lines, gunpower products and so on.
- Avoid the presence of flammable debris around the battery, such as cotton, fabric, haystacks, etc., which may be ignited by sparks and then lead the fire source to the battery, thus causing the battery to burn.
- Not in potential explosive areas.
- Not in the cool air directly.
- Not near the television antenna or antenna cable.
- Not higher than altitude of about 4000m above sea level.
- Not in environment of precipitation or humidity.
- Under good ventilation condition.
- The ambient temperature in the range of -20°C ~ +55°C.
- The slope of the wall should be within $\pm 5^\circ$.
- Suitable for Indoor and outdoor.

The mounting carrier shall meet the following requirements:

- (1) The installation carrier must not be flammable materials;
- (2) The maximum load bearing capacity of the carrier is greater than or equal to 4 times the weight of the unit.



No direct sunlight



No rain exposure



No snow build



Direct sunlight



Rain exposure



Snow lay up

- **Space Requirement**

For the unit:

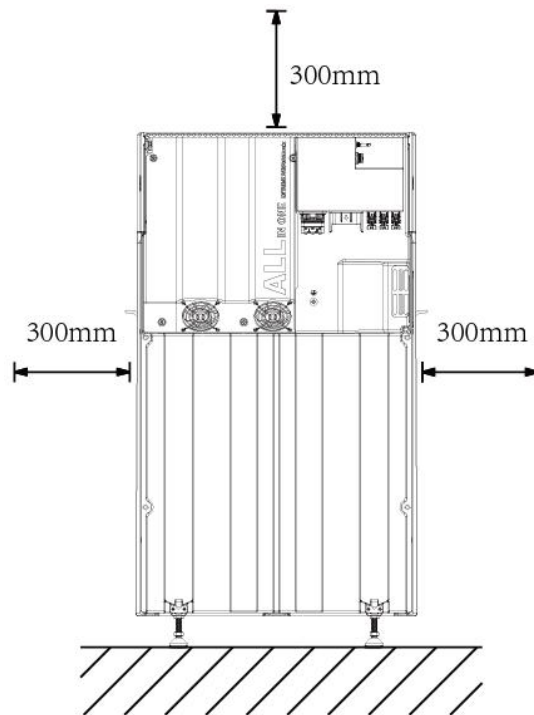

For the bracket:

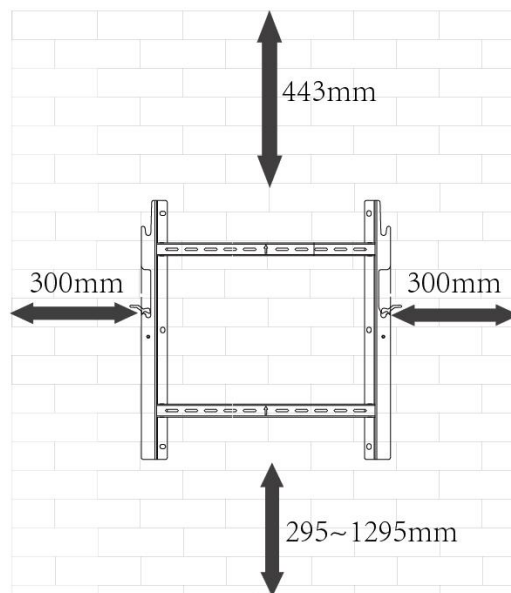

Note: If the bearing capacity of the installation surface is poor, it is recommended that the feet contact the ground, that is, the bottom of the bracket is 295mm away from the ground; if the installation surface is a cement wall, please ensure the height of the bottom of the unit from the ground does not exceed 1000 mm to prevent the product from falling and causing damage to the battery or any other danger.

• **Tools required for installation:**



Hex Key



Safety Shoes



Multimeter



Safety Gloves



Safety Glasses



Spirit Level



Tape



Manual wrench 8mm
& Screwdriver PH2



Hammer Drill
(drill bit set 8mm)



Crimpers



Stripping pliers



Marker

Installation angle requirements:

- Do not tilt the energy storage forward, horizontally, upside down, backward and sideways.

Installation space requirements:

- When installing energy storage system, ensure that there are no other equipment and flammable and explosive materials around, and reserve enough space to ensure the installation heat dissipation and safety isolation requirements.
- During wall-mounted installation, no items are allowed to be placed under the energy storage.

- **Installation Steps**

- Step 1**

Confirm the installation position, place the bracket close to the wall, and mark the position of the installation hole.

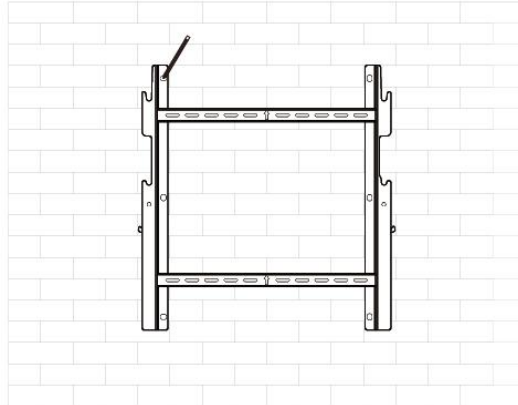

- Step 2**

Drill six 65mm deep holes at the marked locations with a drill bit of 10mm diameter.

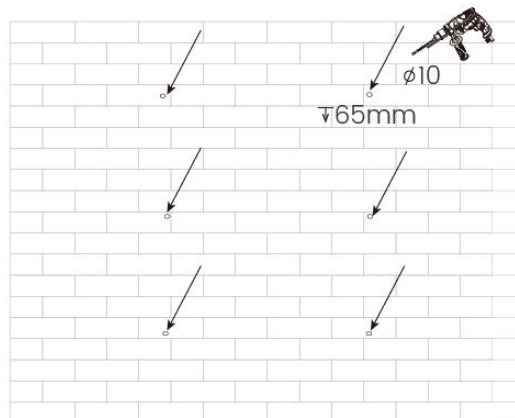

- Step 3**

Align the bracket with the hole, then knock the expansion screws into the holes and tighten it with a screwdriver.

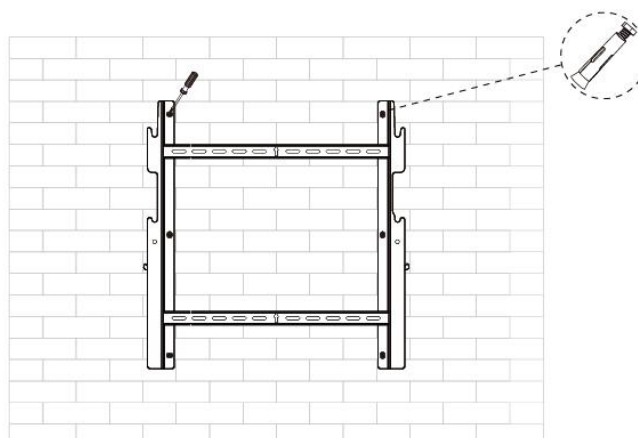

Step 4

Align the four handle screws to the corresponding holes on the box and rotate to tighten them.

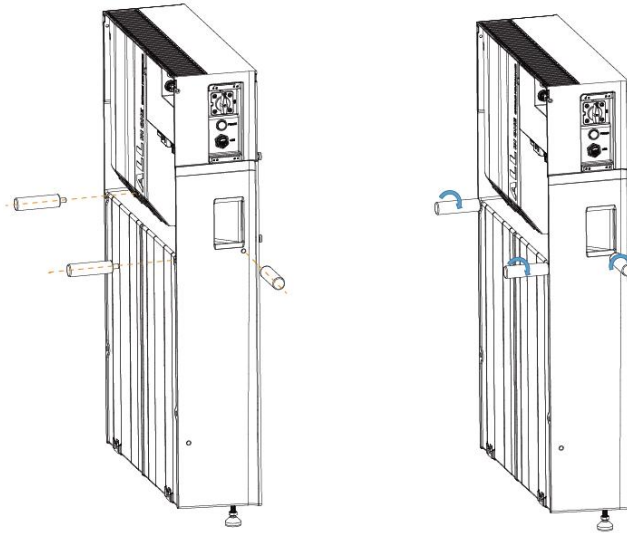

Step 5

Two installers stand on the two sides of the unit, lift the unit by handles and align the screws to the corresponding groove positions of the bracket. Ensure the anti-release hook is fully engaged.

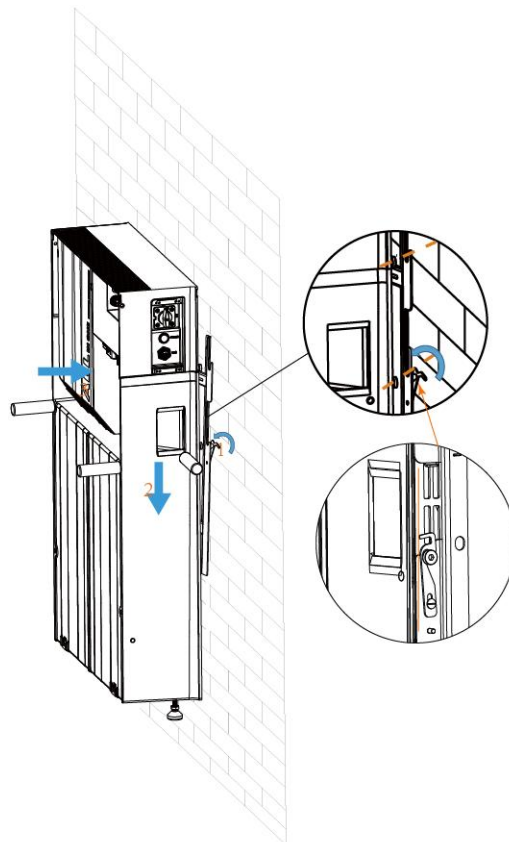

NOTE

The handles and feet can be removed after hanging the unit on the wall.

If the package includes the cover, please implement step 6:

Step 6

After connecting each part of the unit, turn on the switch and start the power supply, and then close the cover. Tighten the screws on both sides of the top to fix the cover and close the side panels.

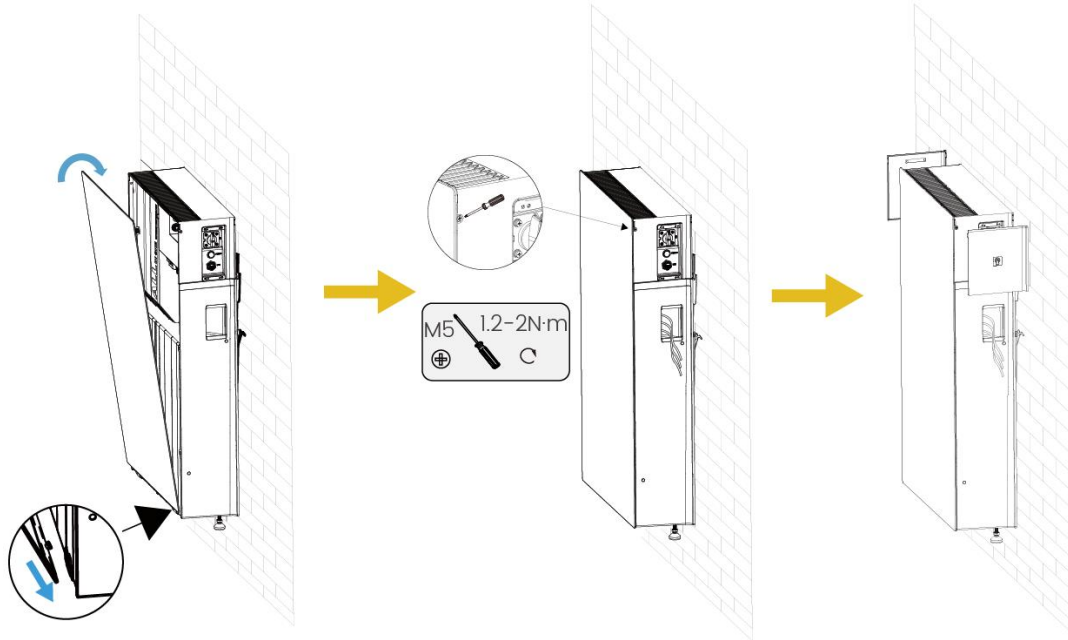

⚠ CAUTION

- (1) Before installing the cover, please make sure that all wiring is completed.
- (2) Before removing the unit from the wall, please dismantle the cover and the hook and install the feet.

Installation of the Cable Entry Cover

1. Tilt the cable entry cover about 30° and press the top firmly against the upper edge of the cable outlet.

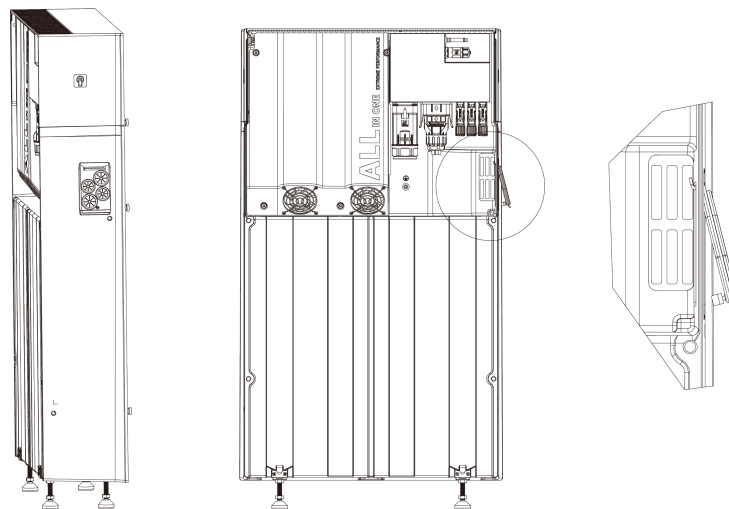

2. There is an L-shaped baffle at the bottom of the cable entry cover that can rotate freely. Manually rotate it 90 degrees so that the cover aligns with the cable outlet. Once released, the cover will automatically rotate to a vertical position due to gravity, or you can manually rotate it to the position shown in the right figure below.

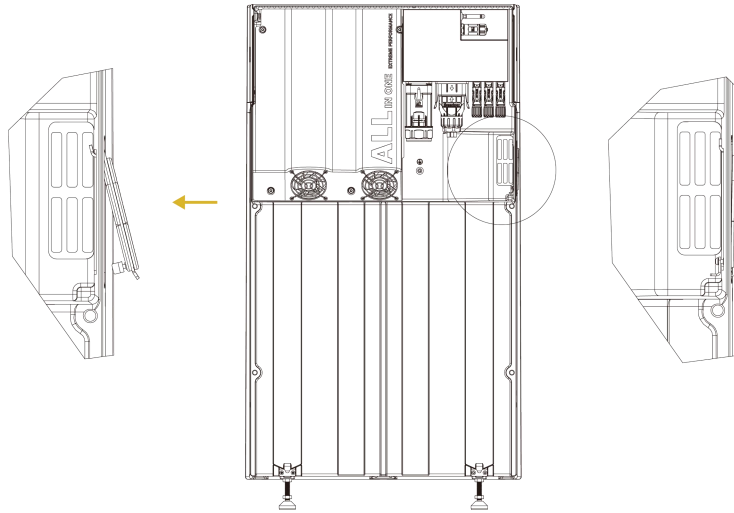

3. The installation of the cable entry cover is complete.

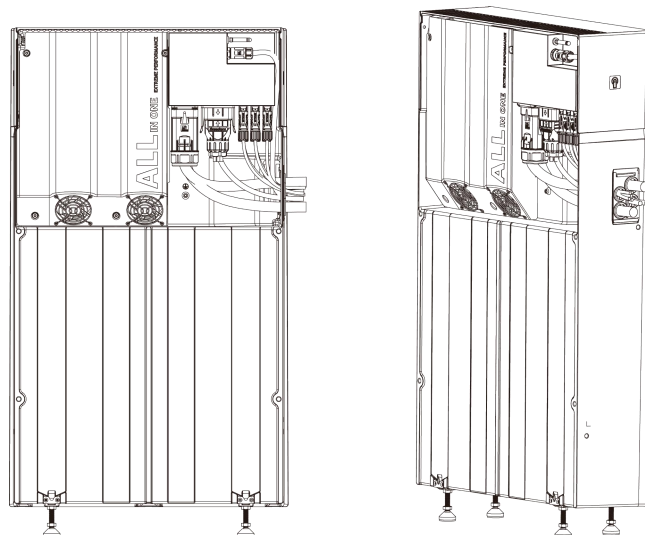

Please follow the steps below to remove the unit from the wall.

Remove the panels on both sides of the unit. Then turn off the power, remove the top two screws, and then remove the cover.

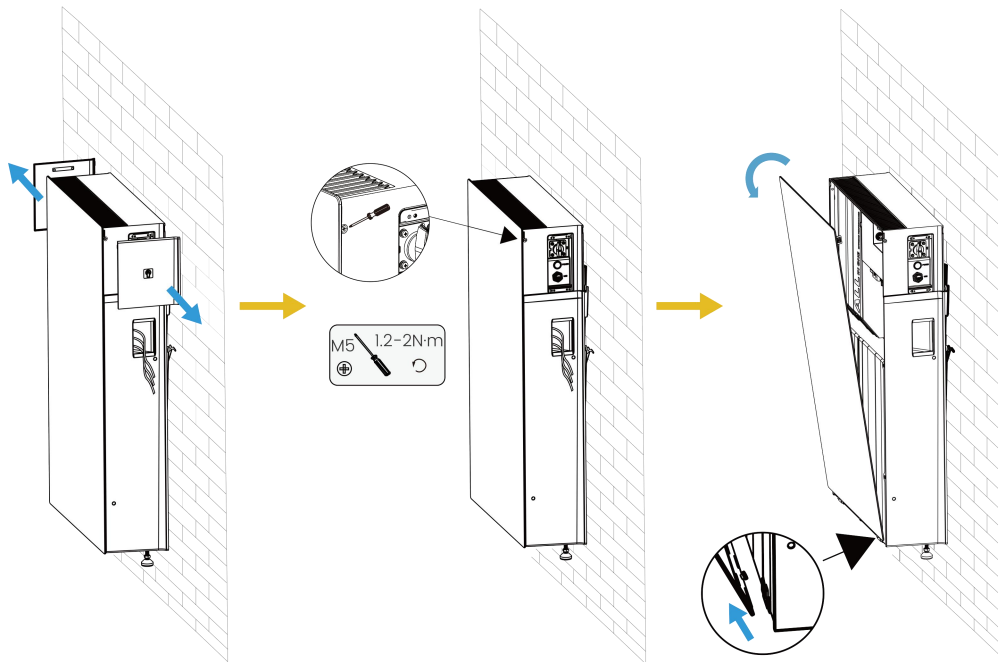

Align the four handle screws with the corresponding holes on the unit and turn to tighten.

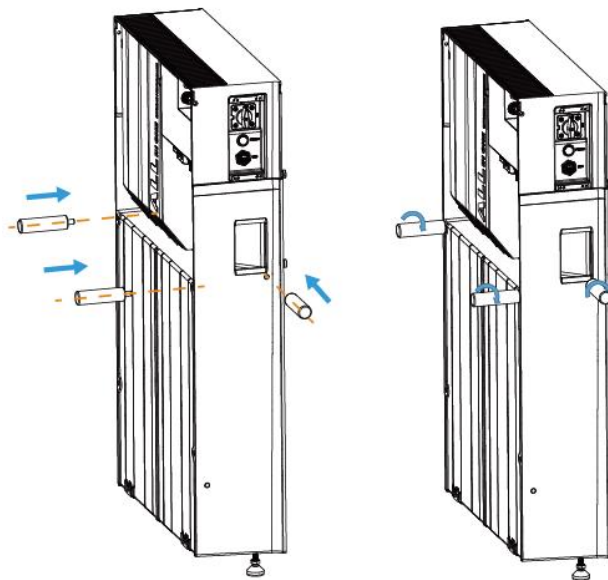

Two people stand on the left and right sides of the unit to lift and remove it outward by the handles.

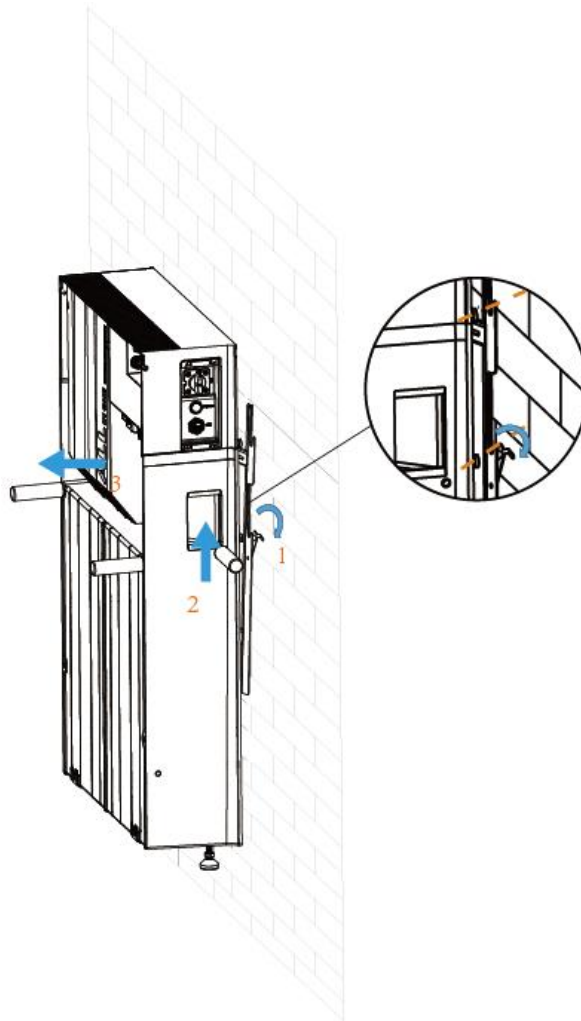

6. Electrical Connection

6.1 Topological Diagram

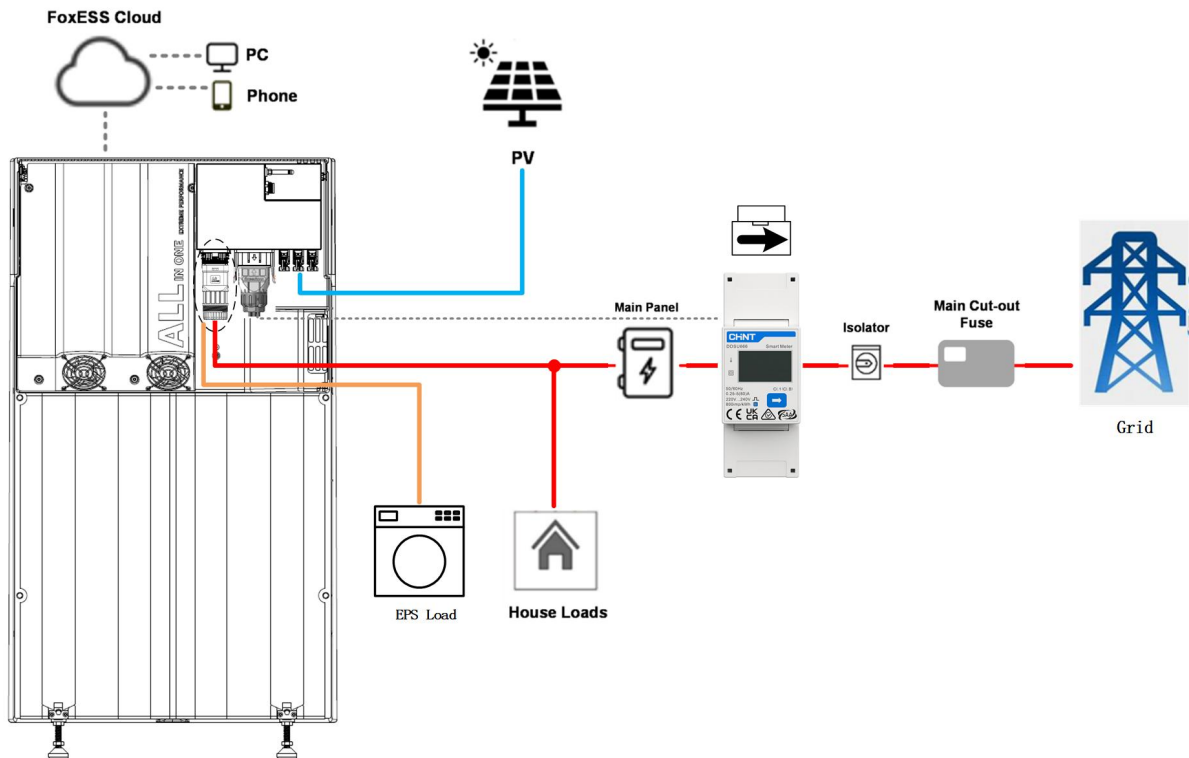

6.2 Earth Connection

Trim 6mm of insulation from the wire end.

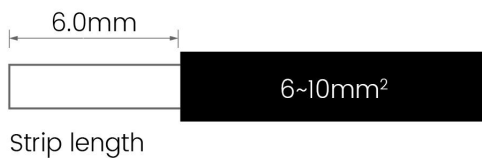

- Insert striped cable into earth terminal and ensure all conductor strands are captured in the earth terminal.
- Crimp the earth terminal with crimper. Put the earth terminal with striped cable into the corresponding crimpers and crimp the contact.

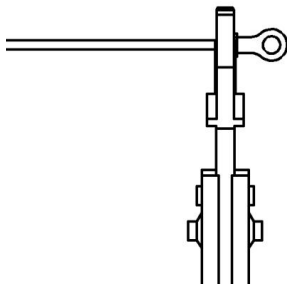

- Press the ground cable into the ground terminal, screw the ground screw with screwdriver as shown below:

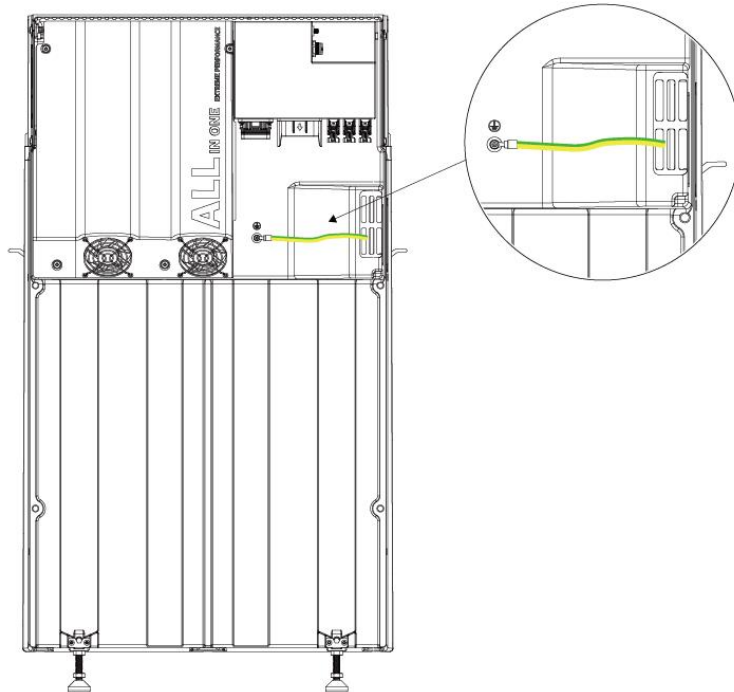

6.3 PV Connection

Step 1: PV String Connection

EVO series all-in-one unit can be connected with 1-string of PV modules. Please select suitable PV modules with high reliability and quality. Open circuit voltage of module array connected should be less than 550V, and operating voltage should be within the MPPT voltage range.

NOTE

Note!

Please choose a suitable external DC switch if the unit does not have a built-in DC Switch.

⚠ WARNING

Warning!

PV module voltage is very high and within a dangerous voltage range, please comply with the electric safety rules when connecting.

⚠ WARNING

Warning!

Please do not make PV positive or negative to ground!

NOTE

Note!

PV modules: Please ensure they are the same type, have the same output and specifications, are aligned identically, and are tilted to the same angle. In order to save cable and reduce DC loss, we recommend installing the unit as near to the PV modules as possible.

Step 2: PV Wiring

- Turn off the DC Switch.
- Choose 2.5mm² wire to connect the PV module.
- Trim 6mm of insulation from the wire end.

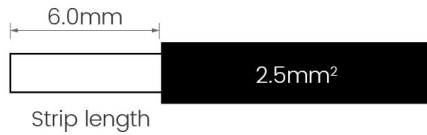

- Separate the DC connector (PV) as below.

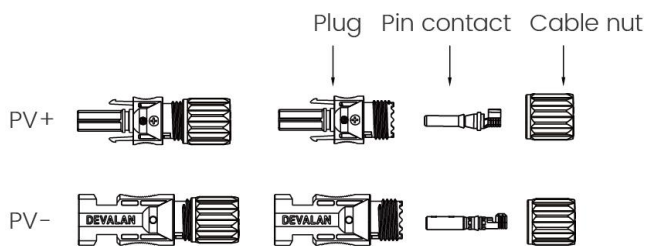

NOTE

When making PV terminals, please make sure that the copper cores of PV positive and PV negative terminals and the copper cores on the unit can be inserted, and use a multimeter to measure whether the positive and negative terminals are correct, otherwise the machine may not work normally or individual strings may not work.

The maximum open-circuit voltage of PV should be less than 550V, otherwise an error may be reported when MPPT cannot be traced.

- Insert striped cable into pin contact and ensure all conductor strands are captured in the pin contact.
- Crimp pin contact with a crimper. Put the pin contact with striped cable into the corresponding crimpers and crimp the contact.

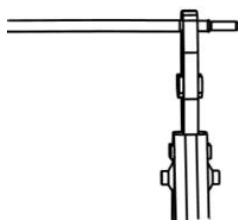

- Insert pin contact through the cable nut to assemble into back of the male or female plug. When you feel or hear a "click" the pin contact assembly is seated correctly.

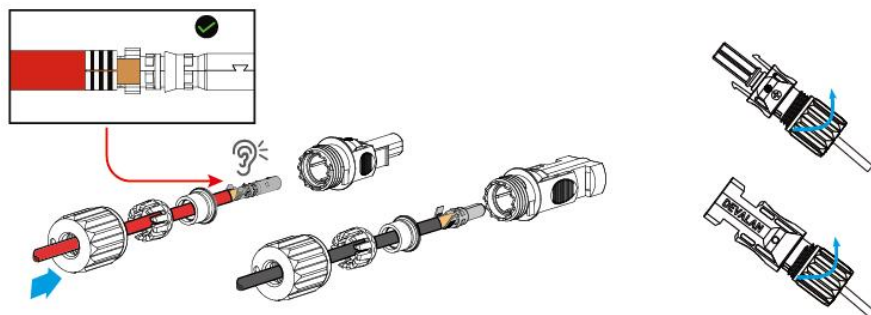

- Unlock the DC connector

⚠ DANGER

Before separating the DC connector, make sure that there is no current on the DC connector. You can measure it with current clamp or disconnect the DC Switch, otherwise serious safety accidents may occur.

- Use the specified wrench tool.
- When separating the DC + connector, push the tool down from the top.
- When separating the DC - connector, push the tool down from the bottom.
- Separate the connectors by hand.

6.4 Grid Connection

Step 1: Grid String Connection

EVO series all-in-one units are designed for single-phase grid. Per voltage range is 220/230/240V; frequency is 50/60Hz. Other technical requests should comply with the requirement of the local public grid.

Power (kW)	3.7	5.0	6.0	7.0	8.0	9.0	9.9	10.0
Cable (ON-GRID)	6.0 mm ²			10.0 mm ²				
Cable (EPS)	6.0 mm ²			10.0 mm ²				
Micro-Breaker	40 A			63 A				

Step 2: Prepare wires

- Check the grid voltage and compare with the permitted voltage range (refer to technical data).
- Disconnect the circuit-breaker from all the phases and secure against re-connection.
- Trim the wires:
 - Trim all the wires to 52.5mm and the PE wire to 55mm.
 - Use the crimpers to trim 12mm of insulation from all wire ends as below.

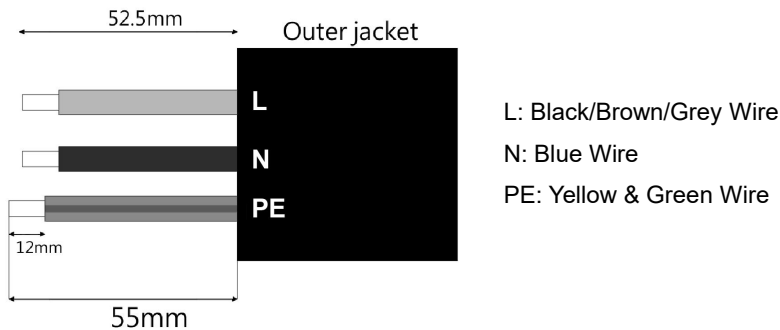

Note: Please refer to local cable type and color for actual installation.

EPS & GRID connector installation:

1. Remove the plug before passing through the cable, and select appropriate sealing ring size.

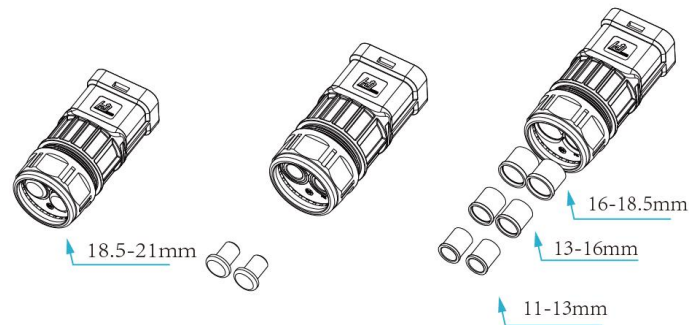

2. Prepare a two-core and a three-core cable or two three-core cables. Strip 65 to 72 mm of the outer sheath from each cable, then strip 16 to 17 mm of insulation from the end of each wire.

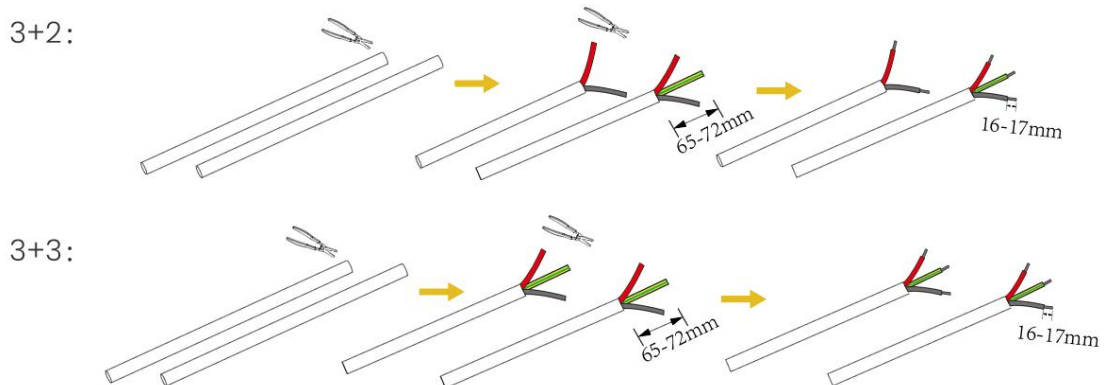

3. Thread the cables into the connectors respectively, then sleeve the sleeves on the cables with the stripped insulation layer, then insert them into the terminal strips, and finally put them into the connectors and tighten the nuts.

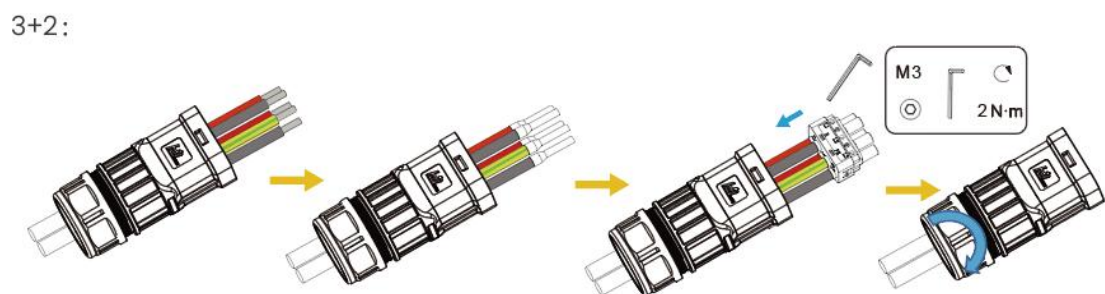

3+3:

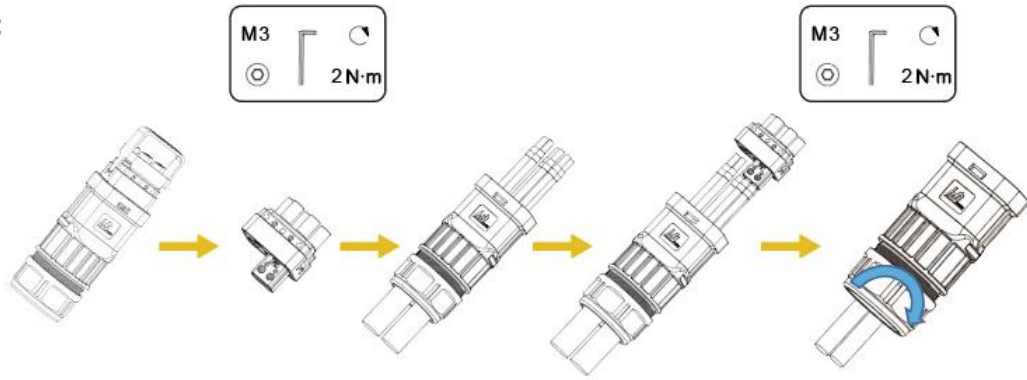

4. Plug the connector into the Grid & EPS port on the board end of the all-in-one unit.

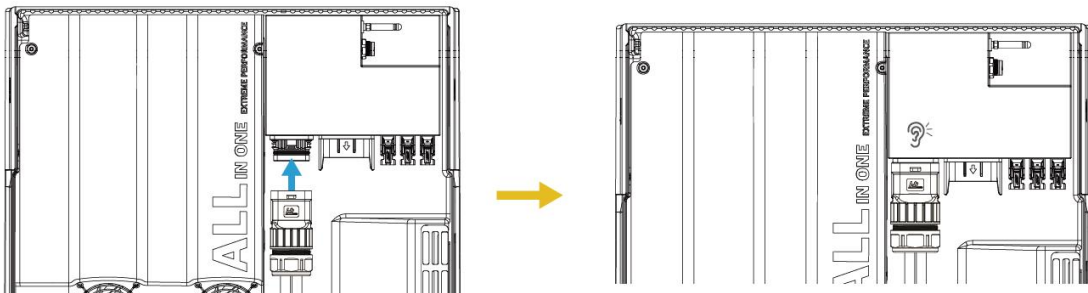

6.5 CT / Meter Connection

The unit has integrated export limitation functionality. To use this function, a power meter must be installed. For Meter installation, please install it on the grid side.

NOTE

When connecting the electricity meter, please make sure that the way of the electricity meter is correct. Otherwise, it will affect the size of the load obtained by the unit and affect the normal operation of the unit. When the battery is available and can work normally, the unit provides the self-test function in the direction of the meter, which can be set in the meter interface.

Export control setting:

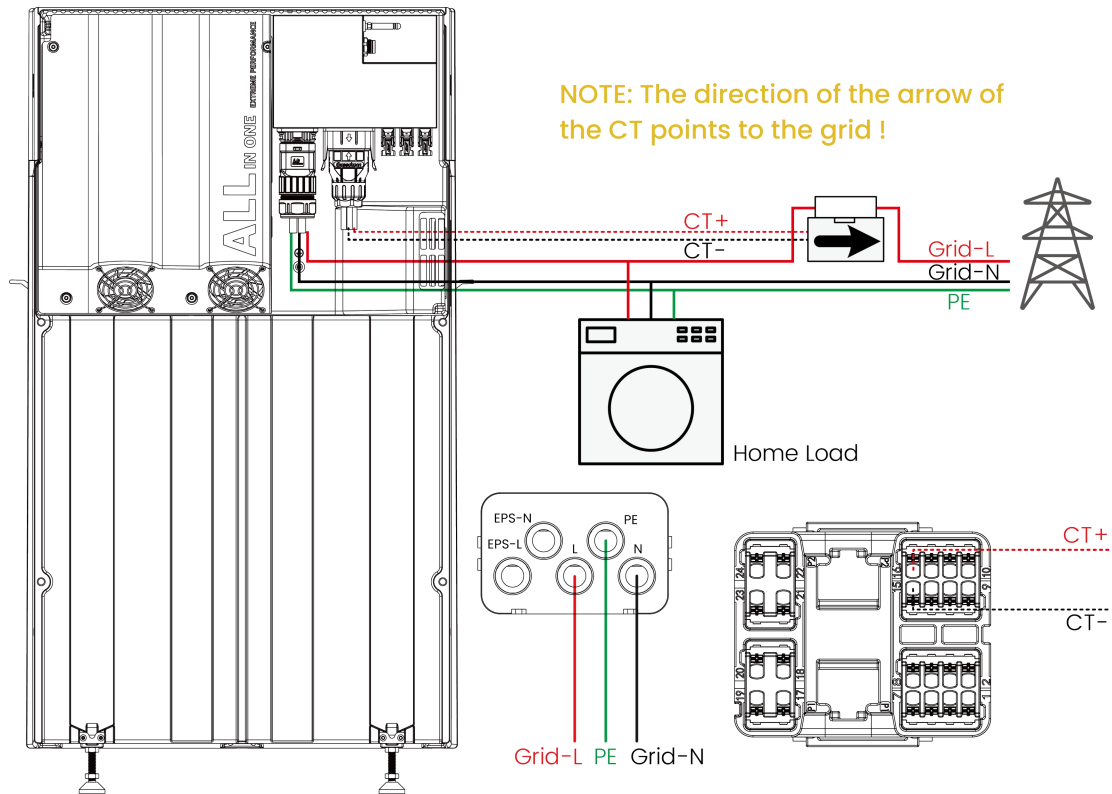
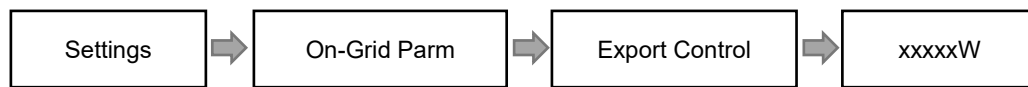

The electricity meter is connected as follows:

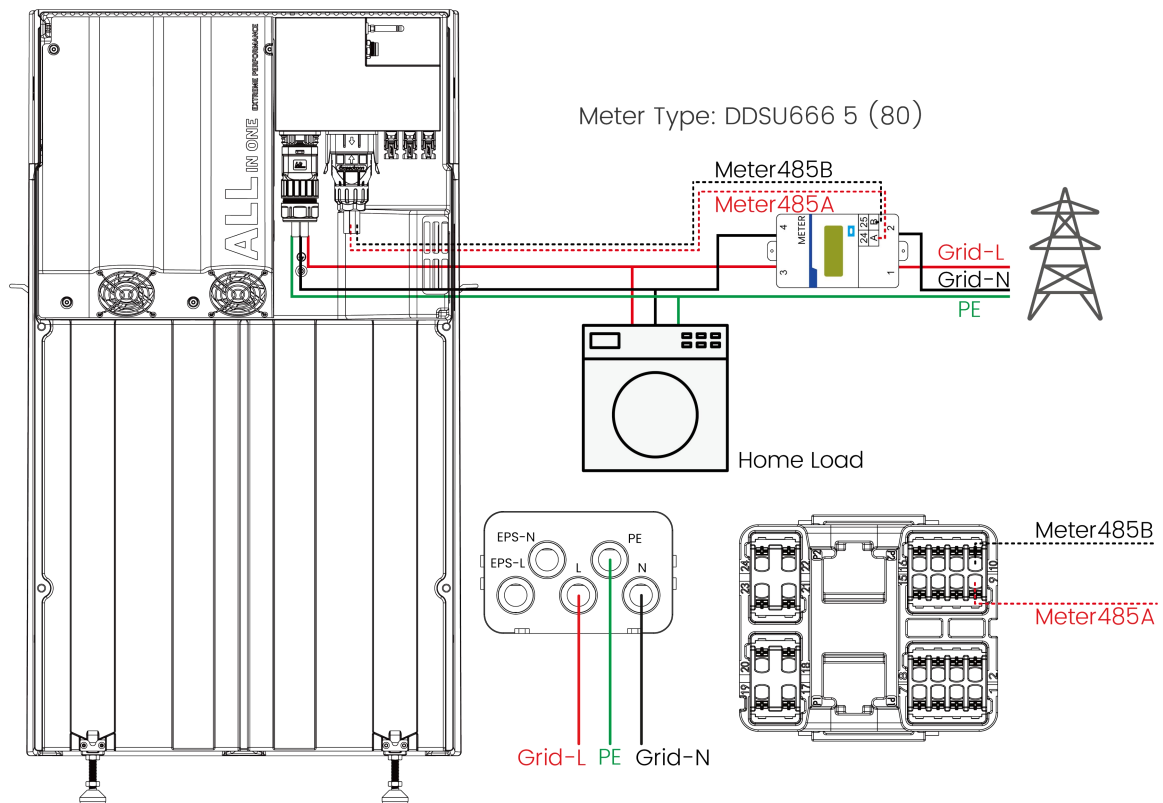

6.6 Communication Interfaces

- LAN connection

The LAN interface can be adapted to conventional T586A and T586B network cables.

The wiring method is as follows.

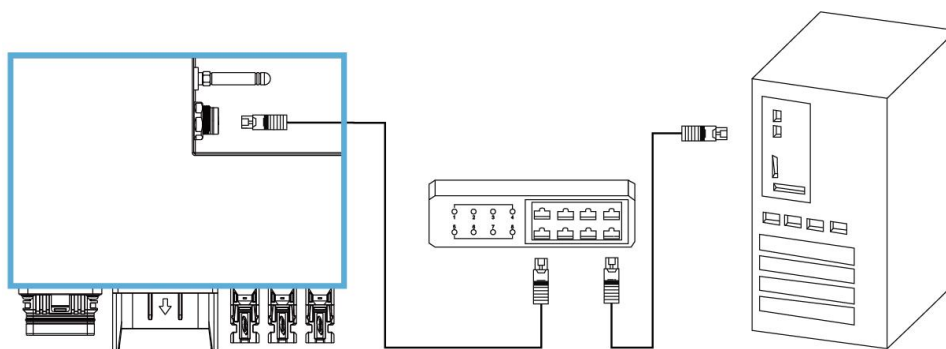

Ethernet connector installation:

1. Insert the network cable into the wire-locking nut, sealing plug and mainbody in turn.

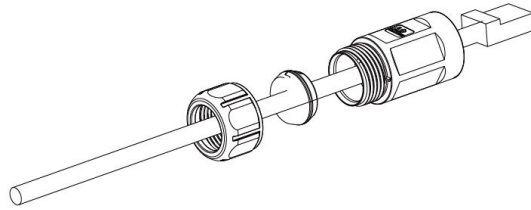

2. Insert the network cable plug into the matched RJ45 panel mount connector.

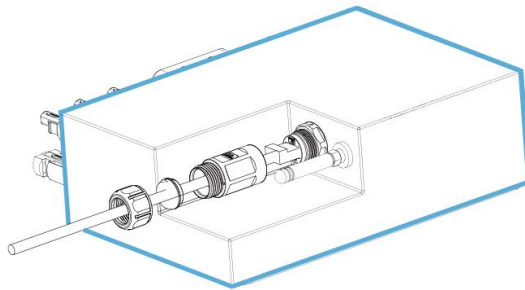

3. Tighten the connector mainbody by an open-ended wrench into the RJ45 panel mount connector with a torque $1.2 \pm 0.2\text{N} \cdot \text{m}$. Then insert the sealing plug into the main body of RJ45 cable end connector. Finally, tighten the connector's nut by an open-ended wrench with a torque $1.2 \pm 0.2\text{N} \cdot \text{m}$.

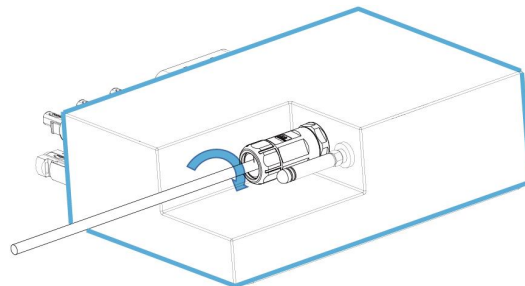

Pin assignment of the RJ45 port and COM port

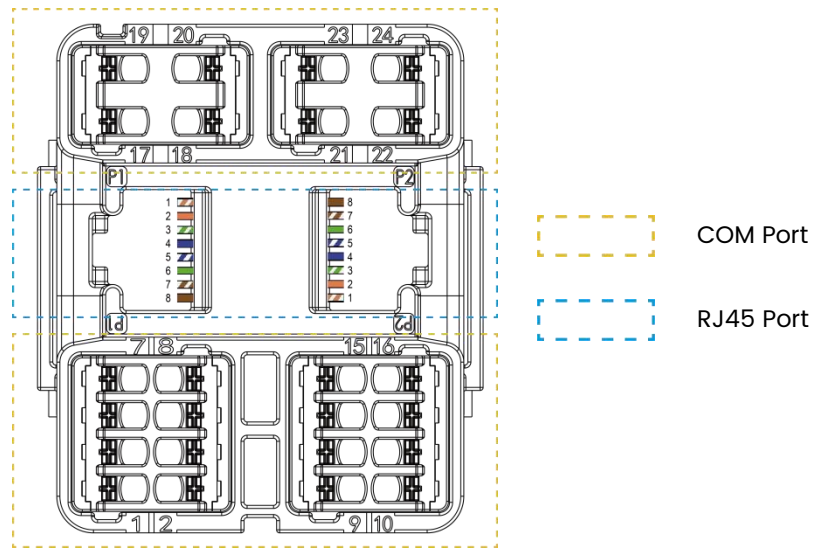

	PIN	PIN Definition		
RJ45 port	1	Paralle_CANH		
	2	Paralle_CANL		
	3	Wifi_485A		
	4	Wifi_485B		
	5	Wifi_485A		
	6	DI		
	7	GND		
	8	12V		
COM port	PIN	PIN Definition	PIN	PIN Definition
	1	DRM1/5	13	CT2+
	2	DRM2/6	14	CT2-
	3	DRM3/7	15	CT1-
	4	DRM4/8	16	CT1+
	5	DRM0	17	K1
	6	RefGen	18	K2
	7	GND	19	K3
	8	Estop	20	K4
	9	Meter_485A	21	Termina_H
	10	Meter_485B	22	Termina_L
	11	485B	23	BMS_CANH
12	485A	24	BMS_CANL	

RJ45 Network Connector Wiring Standard (T568B)

The RJ45 network connector provided is for standard Ethernet connections. To ensure proper network communication and device functionality, you must use the T568B wiring standard when terminating the RJ45 connector on the connecting Ethernet cable.

T568B Wiring Standard

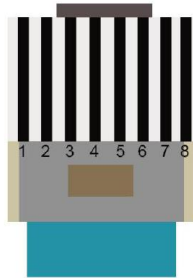

PIN	1	2	3	4	5	6	7	8
Wire Color	White & Orange	Orange	White & Green	Blue	White & Blue	Green	White & Brown	Brown

1 and 2 are used for transmitting, 3 and 6 are used for receiving. 4, 5, 7, and 8 are bi-directional lines. Wires 1 and 2 must form a twisted pair, as must 3 and 6, 4 and 5, and 7 and 8.

Note: The sequence listed above is when viewing the connector with the plastic latch facing downward and the metal contacts facing upward.

COM connector installation:

1. Unscrew the screw at the rear end of the COM connector, unplug the waterproof plug, press the position marked by the arrow and pull it out, and remove the terminal block.

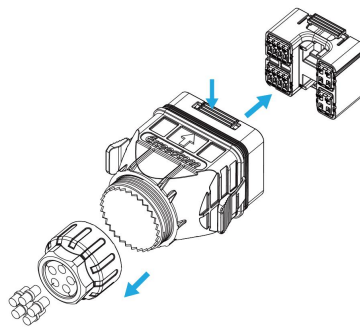

2. Prepare five CAT5E network cables. Peel 35 to 40 mm of the outer skin of the network wires, and then peel 12 to 14 mm of the insulation from the front ends of the wires.

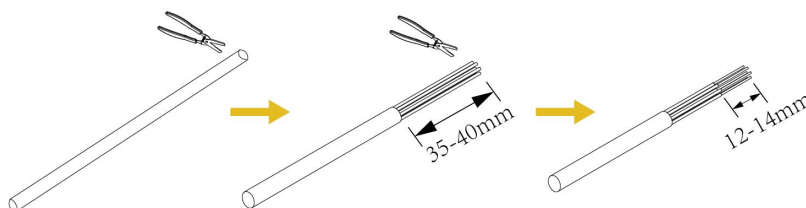

3. Unplug the waterproof plug, thread the cables into the connectors respectively, then sleeve the sleeves on the cables with the insulation stripped off, and crimp the sleeves with sleeve crimping pliers.

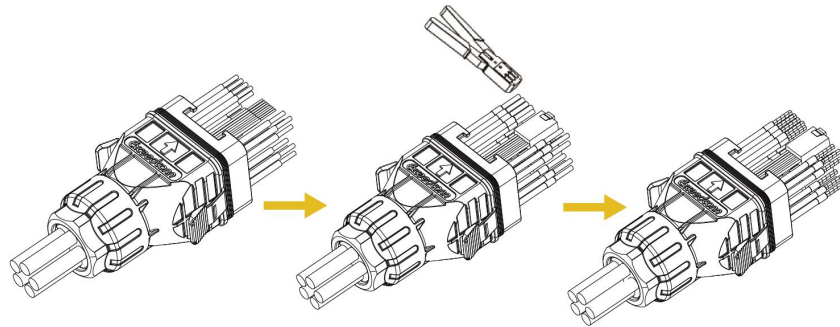

4. Insert the crimped connector into the terminal block and tighten the nut. The COM connector assembly is completed.

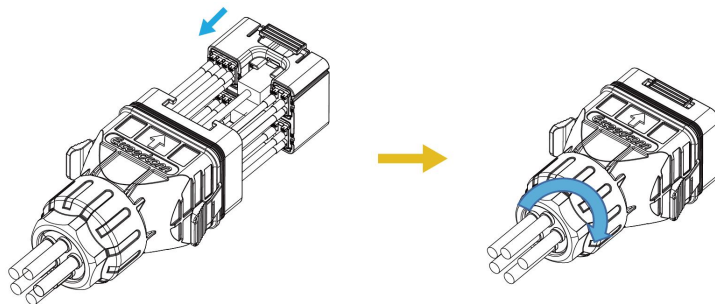

5. Plug the wired connector into the communication port on the board end of the all-in-one unit.

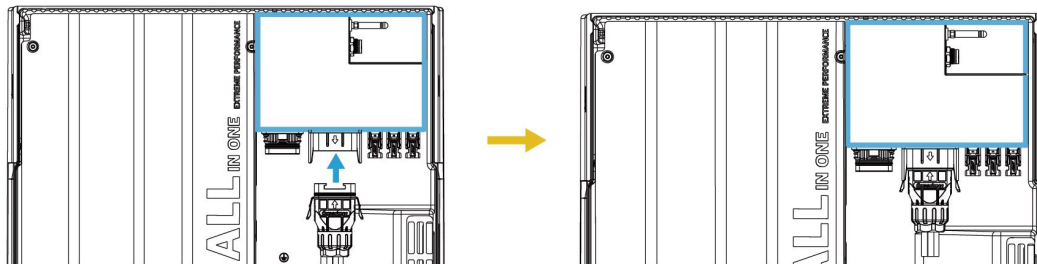

6.7 EPS Wiring (Non-parallel State)

Neutral line of alternative supply must be disconnected after the grid is off. For countries such as China, Germany, the Czech Republic, Italy, etc., please follow local wiring regulations!

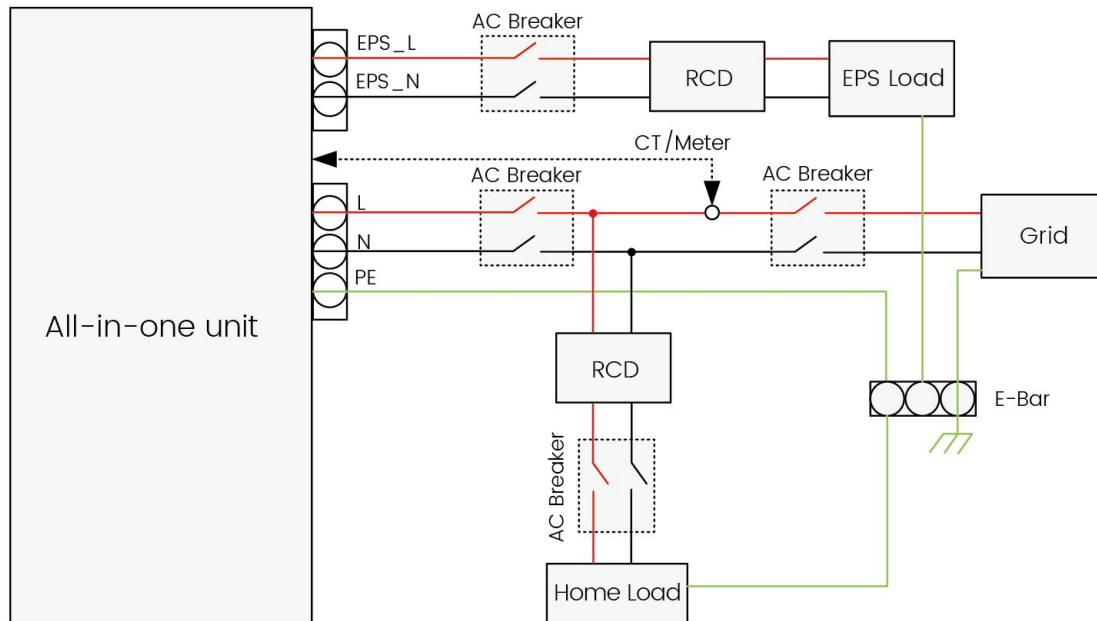

*Recommended RCD specification: 30mA RCD



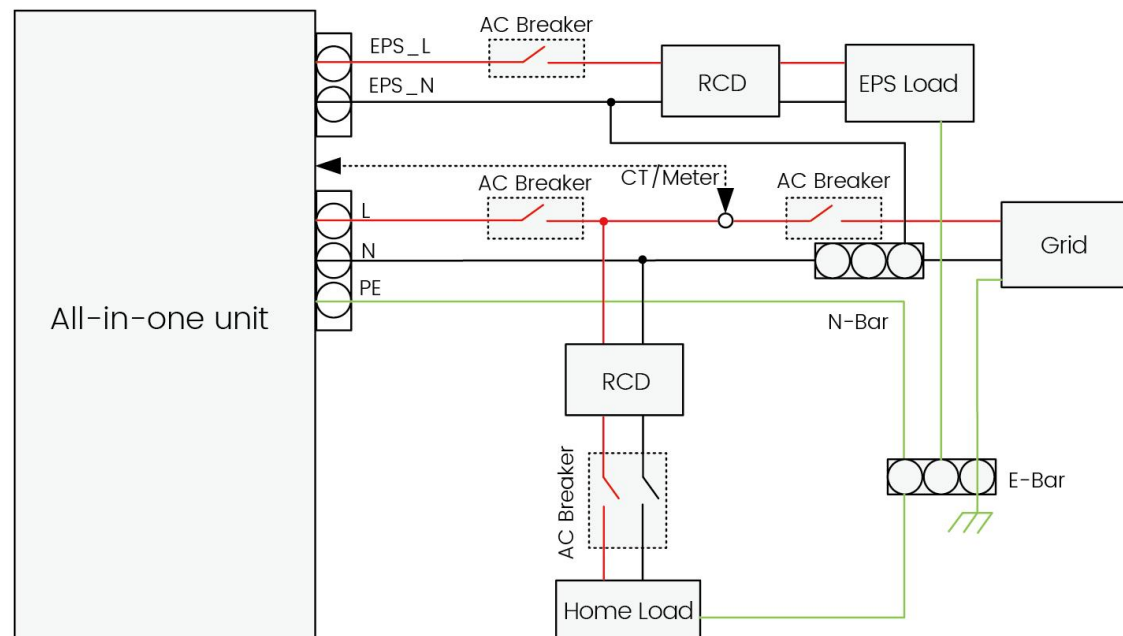





Neutral line of alternative supply must not be isolated or switched. For countries such as Australia, New Zealand, South Africa, etc., please follow local wiring regulations!



*Recommended RCD specification: 30mA RCD

Common loads description

Under EPS mode, if need to connect the inductive load on EPS port, please ensure that the instantaneous power of the load at startup is lower than the maximum power of the EPS mode. Below table shows some conventional and reasonable loads for you reference. Please refer to your loads' manual for the actual specs.

Type	Power		Common equipment	Example		
	Start	Rated		Equipment	Start	Rated
Resistive load	X 1	X 1	 Incandescent lamp  TV	 100W Incandescent lamp	100VA (W)	100VA (W)
Capacitive load	X 2	X 1.5	 Fluorescent lamp	 40W Fluorescent lamp	80VA (W)	60VA (W)
Inductive load	X 3~5	X 2	 Fan  Fridge	 150W Fridge	450-750VA (W)	300VA (W)

*Unipolar load half-wave load are not supported.

*For some motor loads, the starting current may be far more than 5 times the current, which is also not supported.

6.8 System Start-up and Shutdown

System start-up

Please refer to the following steps to start up the all-in-one unit.

- Ensure the unit is securely fixed in place.
- Verify all DC and AC connections are properly completed.
- Confirm the CT/meter is correctly connected.
- Ensure the external EPS contactor is connected (if applicable).
- Turn on the DC Switch.
- Access the settings menu(default password: 0000), select START/STOP and set to START.

NOTE:

- When starting the unit for the first time, the country code will be set by default to the local settings.

Please check if the country code is correct.

- Set the time on the inverter using the button or by using the APP.

System shutdown

Please refer to the following steps to switch off the all-in-one unit.

- Access the settings menu, select START/ STOP, and set it to STOP.
- Access the menu settings, enter the Feature page, select BMS Power Ctrl, and choose OFF.
- Turn off the DC Switch.
- Wait 5 minutes before opening the enclosure cover (if required for maintenance).

6.9 System Black Start

In special cases, such as when the grid and solar panels are not in use, the battery can be activated through the "Black Start" function. This means that our energy storage inverter and battery can continue to operate. The startup steps for black start are as follows.

- First turn on the DC Switch.
- Please press and hold the "POWER" Switch for 7 seconds

NOTE:

Ensure all connections are correct prior to Black Start. No wiring modifications during black start.

7. Main Function Implementation

7.1 Parallel System Wiring and Setting

Each unit supports Max.3 units parallel connection for on-grid system and off-grid system.

System Diagram

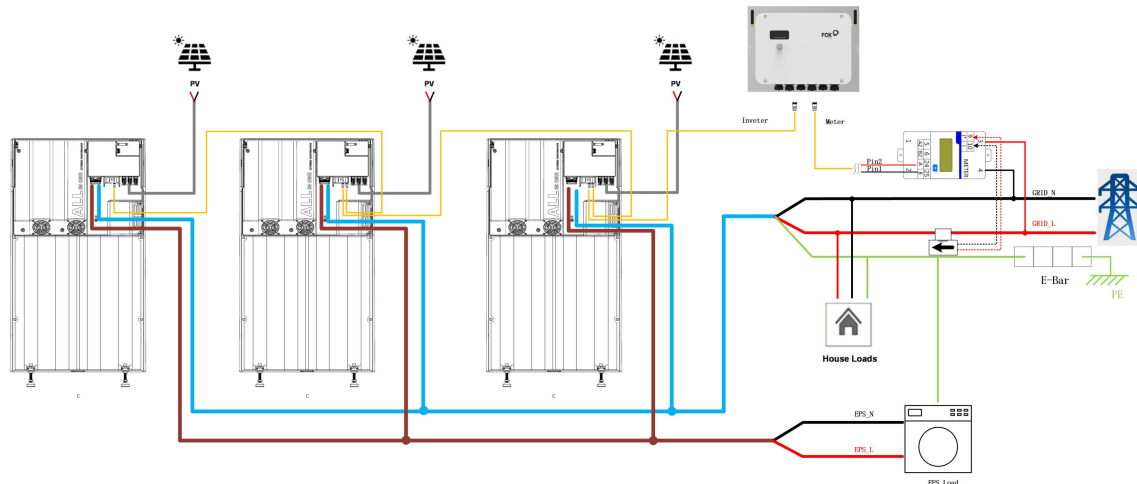

NOTE

- 1) Parallel units need to be of the same type and power.
- 2) For "On grid parallel with EPS load" and "On&off grid parallel" scene, each unit must be connected to the battery.
- 3) The cable length from each inverter's grid port to the grid connection point must be the same, and the cable length from each unit's EPS port to the common load connection point must also be the same.

NOTE

- 1) Parallel systems allow for the connection of devices with varying power and capacity levels.
- 2) For "On grid parallel with EPS load" , "On&off grid parallel " scene, each unit must be connected to the Battery.

⚠ WARNING

On & off grid parallel must ensure that the EPS port and GRID port of each machine are connected one by one. That is, EPS port L of each unit must correspond to L on the network side, and N must correspond to N on the network side.

Does not assume any responsibility for machine damage or safety accidents caused by Wiring error for offline and parallel operation.

1) Wire Connection

Step1: Parallel Power wiring

Step2: Unit communication wiring

Step3: Meter wiring

Step1 Parallel Power wiring

Please select the corresponding power wiring method according to different scenarios.

Step2 Unit communication wiring

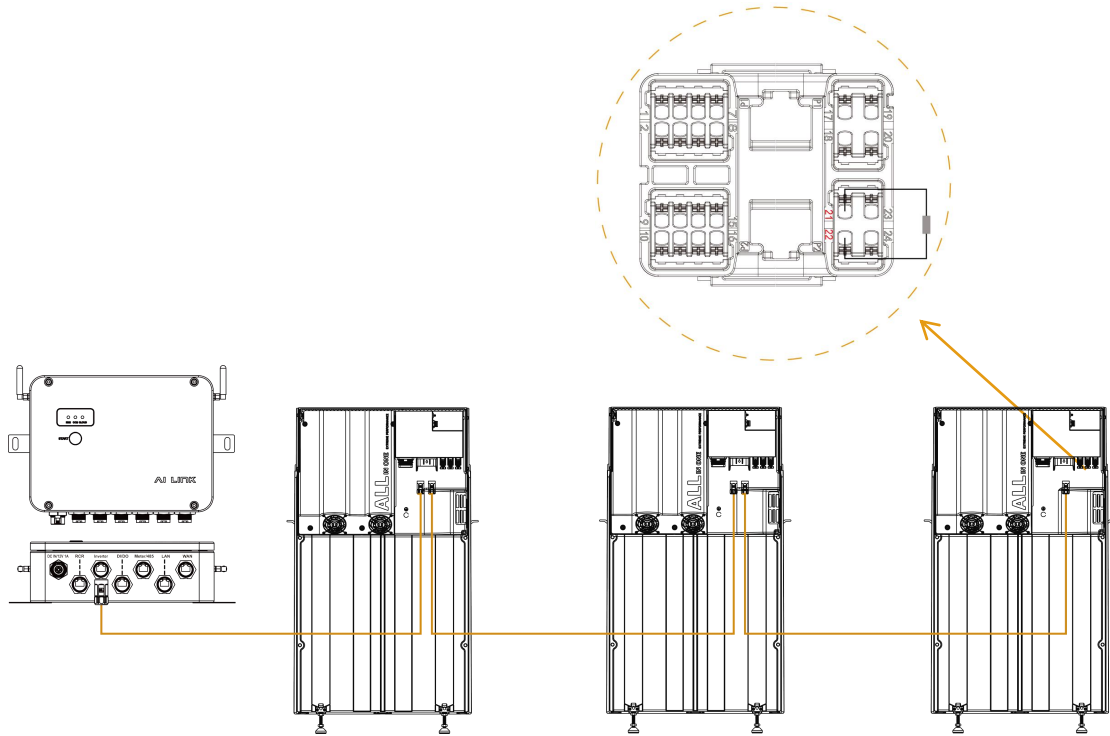

NOTE

The EVO device farthest from the AI Link requires a terminal resistor of 120Ω.

Step3 Meter wiring

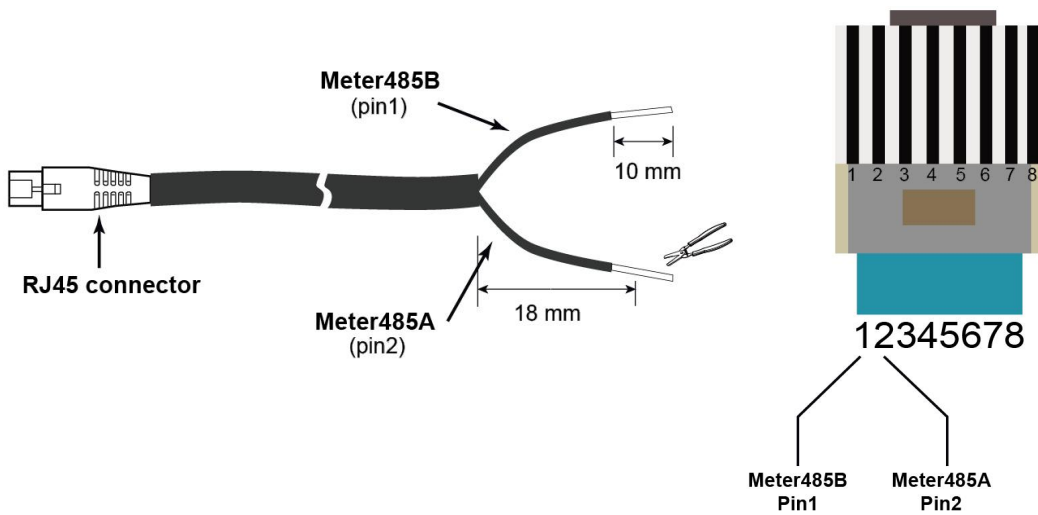

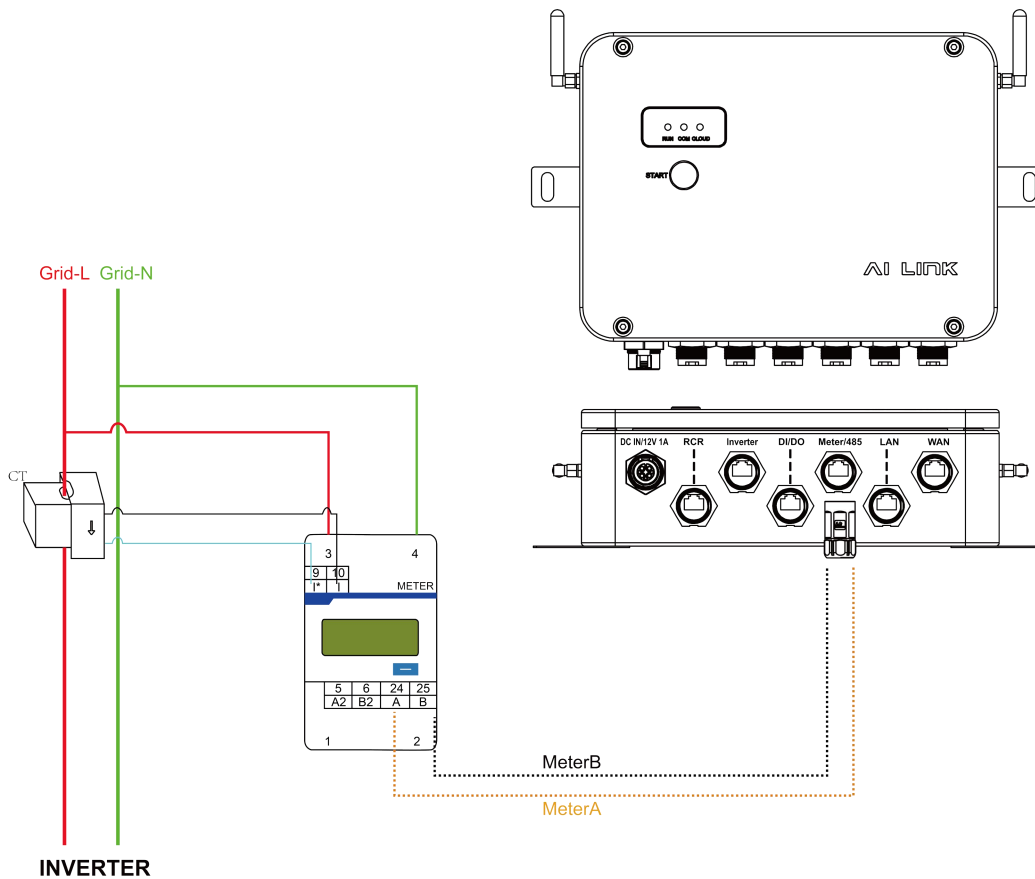

NOTE

- (1) For an energy meter with an external CT type, note that the CT direction should face the inverter.
- (2) As for the meter model, there are two types available for selection, which are DDSU666 230V 5(80)A (PN: 30-803-00026-00) and DDSU666 230V 100A/40mA (PN: 30-803-00032-00). The meter used in the illustration above is the second type.

If off-grid parallel operation is required, set the number of parallel units and parallel addresses under the Off-grid parameters. For three parallel units, set the Num value to 3 for each unit, and assign any non-repeating Address values between 1 and 249 to complete the setup. To exit off-grid parallel operation and switch to standalone mode, set Num to 8 and Address to 250.

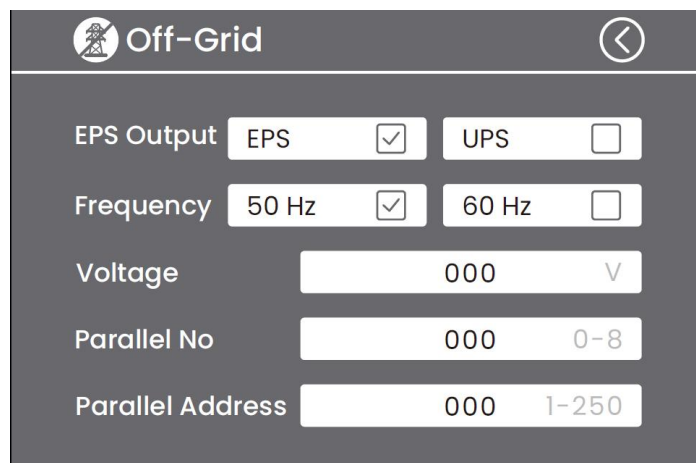

7.2 AI Link Network Configuration and Parameters Setting

AI Link can quickly achieve network configuration and parallel connection via the FoxCloud2.0 app.

Step 1: On the personal center page, click "WLAN Configuration" to enter the network configuration page.

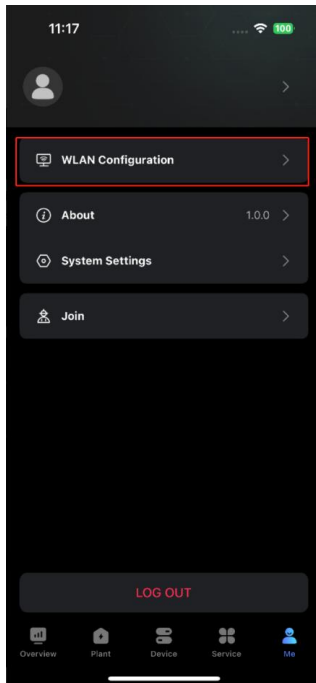

Step 2: On the network configuration page, search for devices.

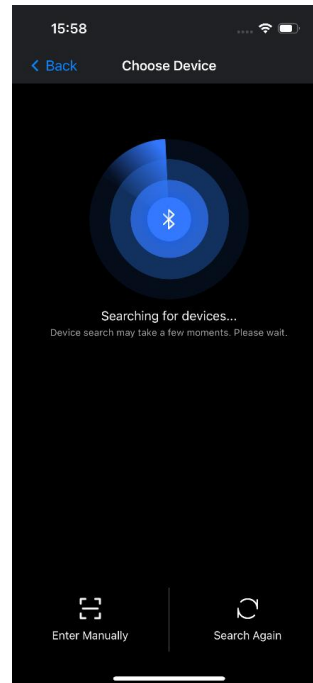

Step 3: After the search is completed, a device list will be displayed. Select the device and click "Connect Network."

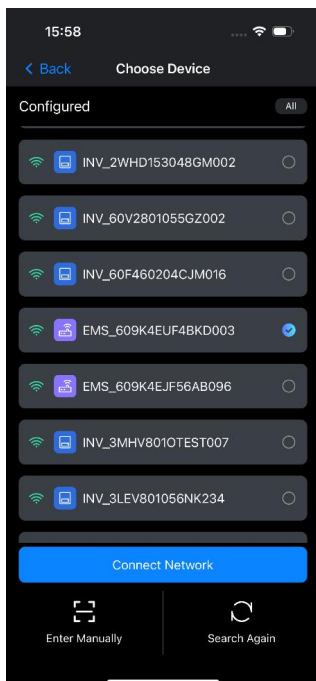

Step 4: Choose a WiFi network, enter the password, and click "Next."

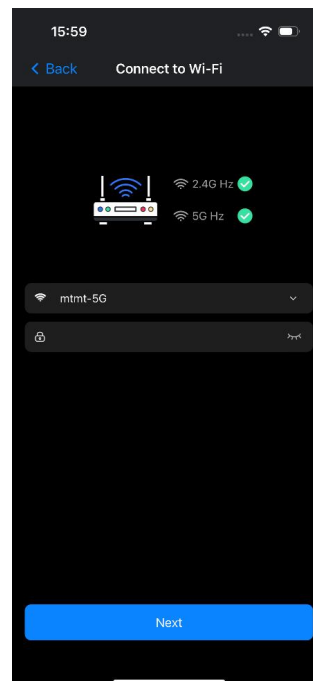

Step 5: Wait for the device to connect to the network.

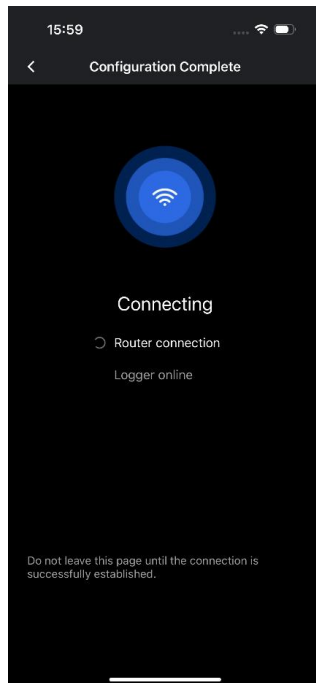

Step 6: The device successfully connects to the network.

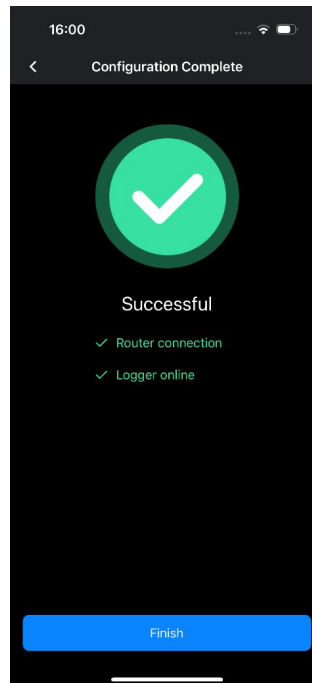

Step 7: Click "Finish" to open the network setup pop-up, which displays the device type and quantity.

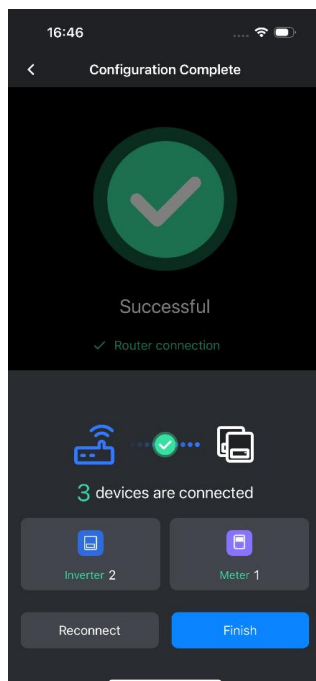

Step 8: If the displayed devices do not match the actual ones, check the on-site machines and wiring issues. Click "Reconnect" to reconfigure the network until all devices are displayed.

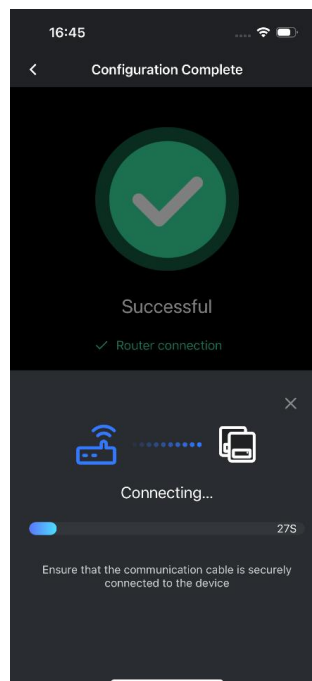

Step 9: After the network setup is successful, click "Finish" to enter the mode selection page. Choose the device connection method and click "Confirm."

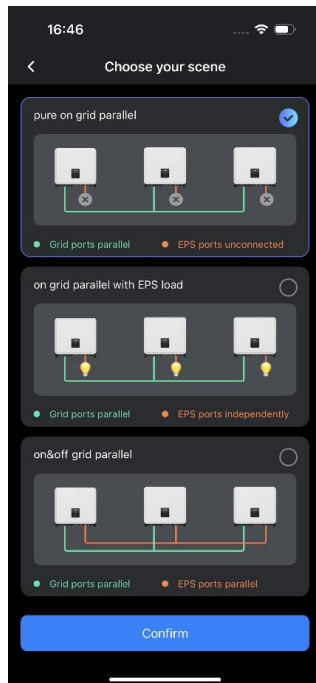

- "Pure on grid parallel" and "On grid parallel with EPS load" are used for grid-tied parallel connection scenarios, corresponding to the "on grid mode" in the machine.
- "On&off grid parallel" is used for off-grid parallel connection scenarios, corresponding to the "on&off grid mode" in the machine.

Step 10: A secondary confirmation pop-up will appear. Check if the connection method is correct. Click "Go back to check" to return to the mode selection page. If the selection is correct, click "Confirm."

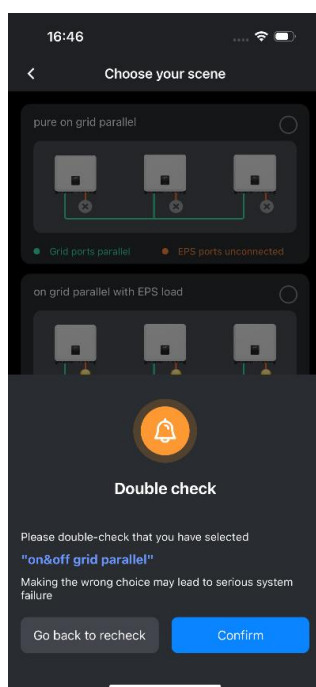

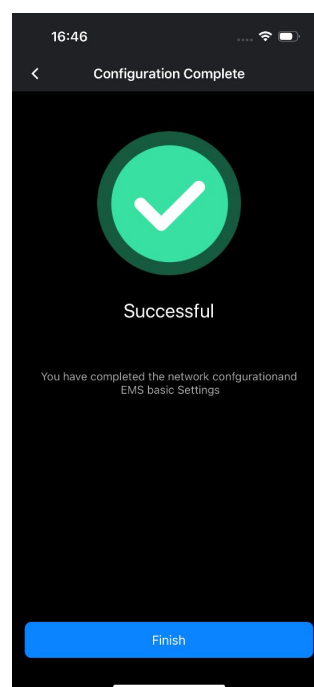

Step 11: The parallel connection is completed. Network configuration and parallel connection are fully accomplished.





Instructions for parameter settings of AI Link on the Fox ESS Cloud platform

Accessing Settings Search for the AI Link using its Serial Number (SN), click the Settings button, and select Device Operation to enter the parameter configuration interface.

609K4F5F4BQB150  

+ New Tag

No.	SN	Site	Model	Grid-connected Time	Country / Region	Status	Operation
1	609K4F5F4BQB150	f-g test	Smart LogBox-A	2024-11-27 10:00:02 CS...	China	●	 



(1) AC Output Control: DRM/Ripple Control

ems-SN : 609K4F5F4BQB150

[Restart](#) [Remote maintenance](#) [Address allocation](#)

Ac Output Control

Power Limit Control

More

Gen

* DRM

* Ripple Control

* Ripple Control Piecewise-1 (0~100)%

* Ripple Control Piecewise-2 (0~100)%

* Ripple Control Piecewise-3 (0~100)%

* Ripple Control Piecewise-4 (0~100)%

[OK](#)

(2) Power Limit Control

ems-SN : 609K4F5F4BQB150

[Restart](#) [Remote maintenance](#) [Address allocation](#)

Ac Output Control

Power Limit Control

More

Gen

* Power limit

* Grid export limit W

* Grid import limit W

* Grid export limit(forPeakShaving) W

* Battery SOC limit(forPeakShaving) (0~100)%

* AC output export limit W

[OK](#)

8. Firmware Upgrading

Users can upgrade the unit's firmware via a U-disk.

• Safety check

Please ensure the unit is steadily powered on.

Please keep the battery on through the whole procedure of upgrading. Please prepare a PC and make sure the size of U-disk is under 32G, and the format is fat 16 or fat 32.



Caution!

Please DO NOT apply USB3.0 U-disk on inverter USB port, the inverter USB port only support for USB2.0 U-disk.

• Upgrading steps:

Step 1: Please contact our service support to get the update files, and extract it into your U-disk as follows:

update/master/ 812_Master_Vx.xx.bin

update/slave/ 812_Slave_V.xx.bin

update/manager/ 812_Manager_Vx.xx.bin

Note: vx.xx is version number.

Warning: Make sure the directory is in accordance with above form strictly! Do not modify the program file name, or it may cause the inverter not work anymore!

Step 2: Unscrew the waterproof lid and insert U-disk into the "USB" port on the unit.

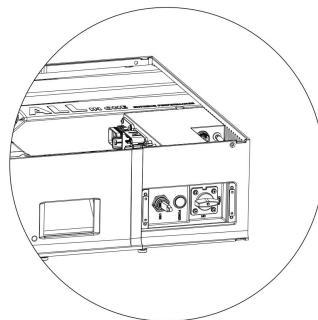

Step 3: Upon inserting a USB flash drive, the firmware update page will automatically pop up. Click on different icons to switch views; the option with a white background indicates selection.

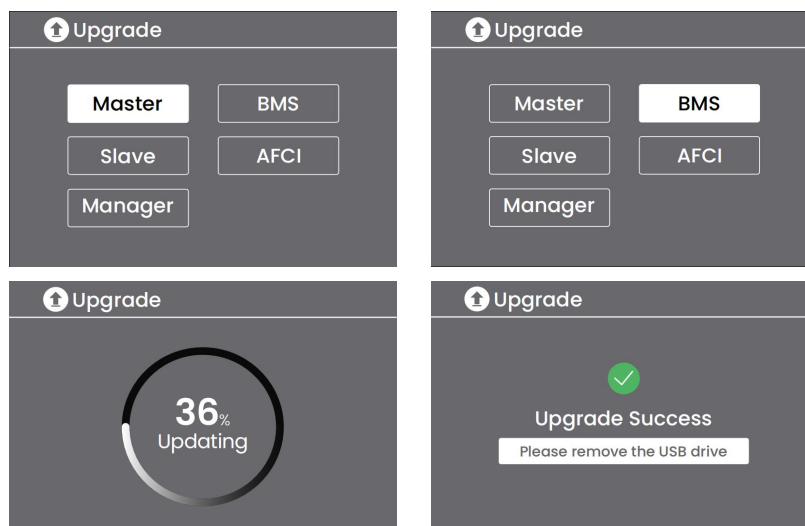

9. Operation

9.1 Control Panel

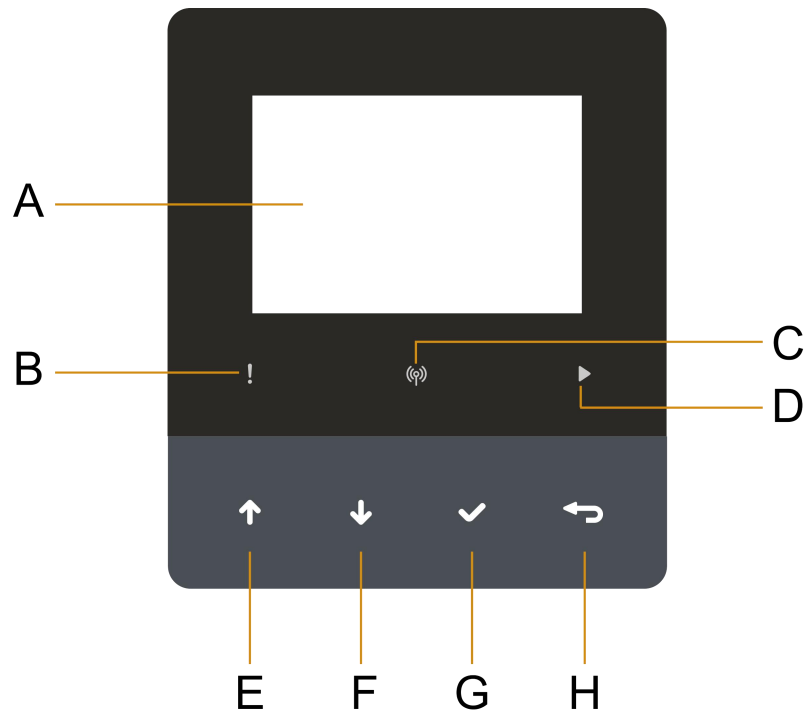

Object	Name	Function
A	LCD screen	Display the information of the energy station and support touchscreen.
B	Indicator LED	Red: The energy station is in fault mode.
C		Blue: Light off - no network connection Blink - connect to the internet Light on - connect successfully
D		Green: The energy station is in normal state.
E		Up button: Move cursor to upside or increase value.
F	Function button	Down button: Move cursor to downside or decrease value.
G		OK button: Confirm the selection.
H		Return button: Return the previous operation.

9.2 Introduction to the User Interface (UI)

On the Home screen, tap any area block to jump directly to details where you can view information such as Battery, Solar, Grid, EPS, and Temperature.

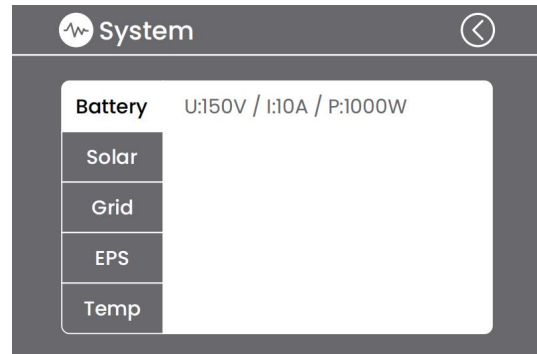
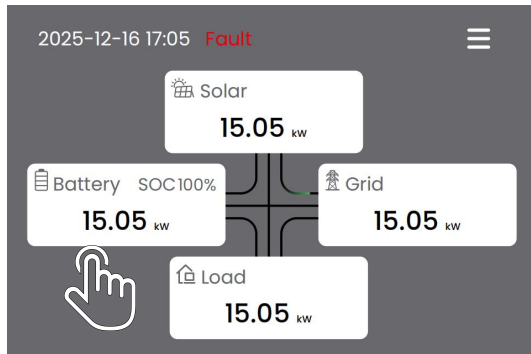

Click the icon in the upper-right corner of the Home screen to access the menu page. Select Settings and enter your password to enter the password-protected sub-menu.

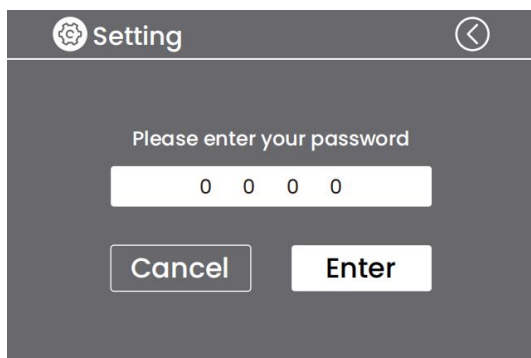
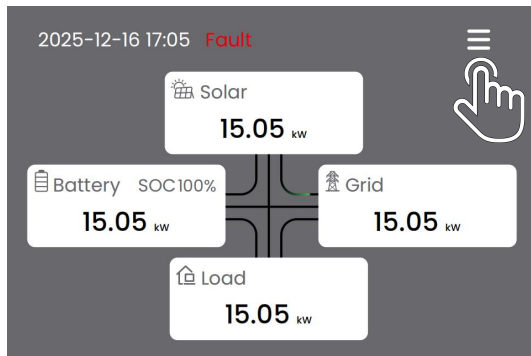

Function Tree:

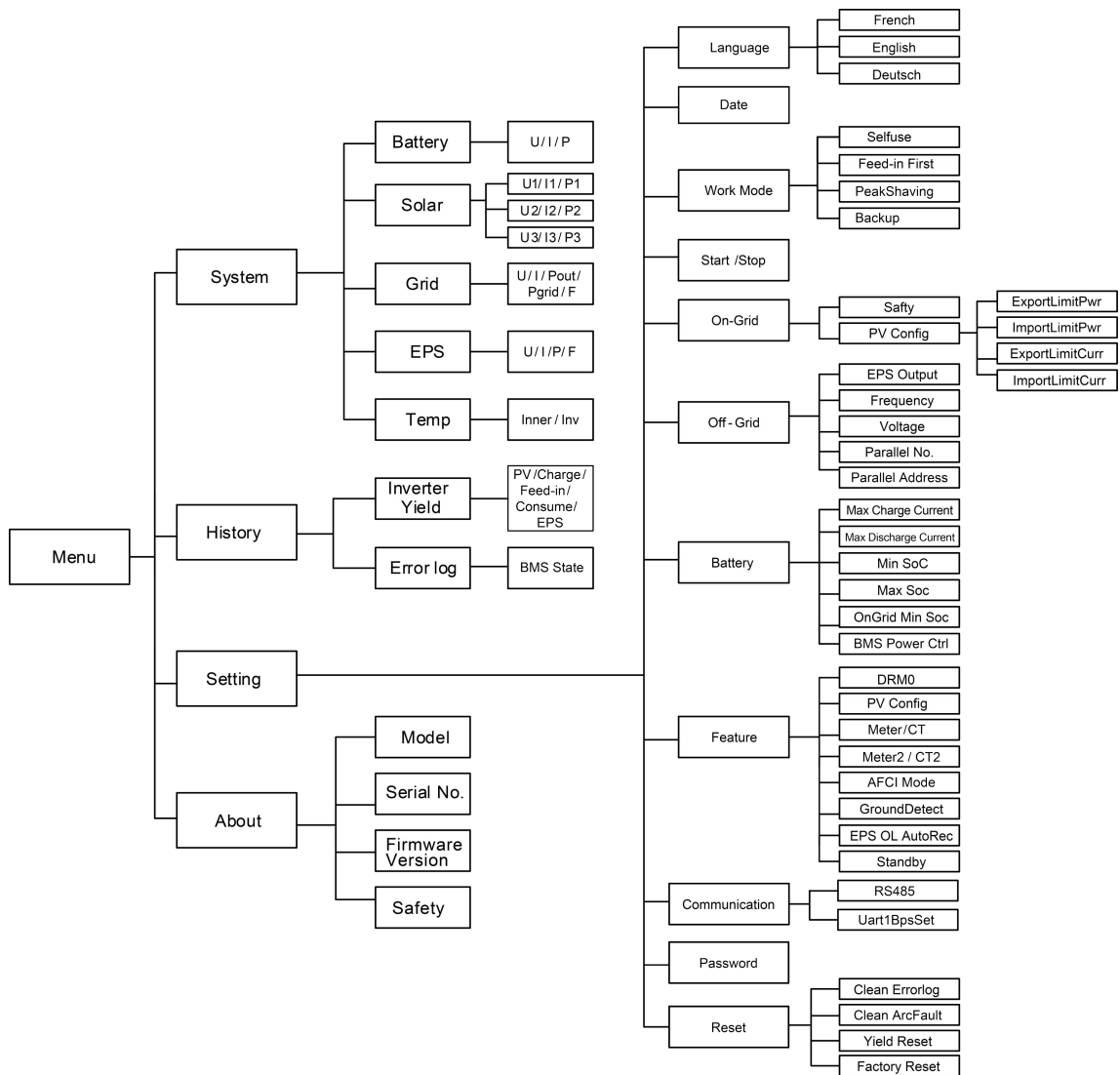

10. Maintenance

This section contains information and procedures for solving possible problems with the inverters and provides you with troubleshooting tips to identify and solve most problems that can occur.

10.1 Alarm List

Fault Code	Solution
Grid Lost Fault	Grid is lost. <ul style="list-style-type: none"> • System will reconnect if the utility is back to normal. • Or seek help from us, if not go back to normal state.
Grid Volt Fault	Grid voltage out of range. <ul style="list-style-type: none"> • System will reconnect if the utility is back to normal. • Or seek help from us, if not go back to normal state.
Grid Freq Fault	Grid frequency out of range. <ul style="list-style-type: none"> • System will reconnect if the utility is back to normal. • Or seek help from us, if not go back to normal state.
10min Volt Fault	The grid voltage is out of range for the last 10 Minutes. <ul style="list-style-type: none"> • System will reconnect if the utility is back to normal. • Or seek help from us, if not go back to normal state.
SW Inv Cur Fault	Output current high detected by software. <ul style="list-style-type: none"> • Disconnect PV, grid and battery, then reconnect. • Or seek help from us, if not go back to normal state.
DCI Fault	DC component is out of limit in output current. <ul style="list-style-type: none"> • Disconnect PV, grid and battery, then reconnect. • Or seek help from us, if not go back to normal state.
HW Inv Cur Fault	Output current high detected by hardware. <ul style="list-style-type: none"> • Disconnect PV, grid and battery, then reconnect. • Or seek help from us, if not go back to normal state.
SW Bus Vol Fault	Bus voltage out of range detected by software. <ul style="list-style-type: none"> • Disconnect PV, grid and battery, then reconnect. • Or seek help from us, if not go back to normal state.
Bat Volt Fault	Battery voltage fault. <ul style="list-style-type: none"> • Check if the battery input voltage is within the normal range. • Or seek help from us.

SW Bat Cur Fault	<p>Battery current high detected by software.</p> <ul style="list-style-type: none"> • Disconnect PV, grid and battery, then reconnect. • Or seek help from us, if not go back to normal state.
Iso Fault	<p>The isolation is failed.</p> <ul style="list-style-type: none"> • Please check if the insulation of electric wires is damaged. • Wait for a while to check if back to normal. • Or seek for help from us.
Res Cur Fault	<p>The residual current is high.</p> <ul style="list-style-type: none"> • Please check if the insulation of electric wires is damaged. • Wait for a while to check if back to normal. • Or seek for help from us.
Pv Volt Fault	<p>PV voltage out of range.</p> <ul style="list-style-type: none"> • Please check the output voltage of PV panels. • Or seek for help from us.
SW Pv Cur Fault	<p>PV input current high detected by software.</p> <ul style="list-style-type: none"> • Disconnect PV, grid and battery, then reconnect. • Or seek help from us, if not go back to normal state.
Temp Fault	<p>The inverter temperature is high.</p> <ul style="list-style-type: none"> • Please check if the environment temperature. • Wait for a while to check if back to normal. • Or seek for help from us.
Ground Fault	<p>The ground connection is failed.</p> <ul style="list-style-type: none"> • Check the voltage of neutral and PE. • Check AC wiring. • Disconnect PV, grid and battery, then reconnect. • Or seek help from us, if not go back to normal state.
Over Load Fault	<p>Over load in on grid mode.</p> <ul style="list-style-type: none"> • Please check if the load power exceeds the limit. • Or seek for help from us.
Eps Over Load	<p>Over load in off grid mode.</p> <ul style="list-style-type: none"> • Please check if the eps load power exceeds the limit. • Or seek for help from us.
Bat Power Low	<p>The battery power is low.</p> <ul style="list-style-type: none"> • Wait the battery to be recharged. • Or seek for help from us.
HW Bus Vol Fault	<p>Bus voltage out of range detected by hardware.</p> <ul style="list-style-type: none"> • Disconnect PV, grid and battery, then reconnect. • Or seek help from us, if not go back to normal state.

HW Pv Cur Fault	<p>PV input current high detected by hardware.</p> <ul style="list-style-type: none"> • Disconnect PV, grid and battery, then reconnect. • Or seek help from us, if not go back to normal state.
HW Bat Cur Fault	<p>Battery current high detected by hardware.</p> <ul style="list-style-type: none"> • Disconnect PV, grid and battery, then reconnect. • Or seek help from us, if not go back to normal state.
SCI Fault	<p>The communication between master and manager is fail.</p> <ul style="list-style-type: none"> • Disconnect PV, grid and battery, then reconnect. • Or seek help from us, if not go back to normal state.
MDSP SPI Fault	<p>The communication between master and slave is fail.</p> <ul style="list-style-type: none"> • Disconnect PV, grid and battery, then reconnect. • Or seek help from us, if not go back to normal state.
MDSP Smpl Fault	<p>The master sample detection circuit is failed.</p> <ul style="list-style-type: none"> • Disconnect PV, grid and battery, then reconnect. • Or seek help from us, if not go back to normal state.
Res Cur HW Fault	<p>Residual current detection device is failed.</p> <ul style="list-style-type: none"> • Disconnect PV, grid and battery, then reconnect. • Or seek help from us, if not go back to normal state.
Inv EEPROM Fault	<p>The inverter eeprom is fault.</p> <ul style="list-style-type: none"> • Disconnect PV, grid and battery, then reconnect. • Or seek help from us, if not go back to normal state.
PvCon Dir Fault	<p>The PV connection is reversed.</p> <ul style="list-style-type: none"> • Check if the positive pole and negative pole of PV are correctly connected. • Or seek help from us.
Bat Relay Open	<p>The battery relay keeps open.</p> <ul style="list-style-type: none"> • Disconnect PV, grid and battery, then reconnect. • Or seek help from us, if not go back to normal state.
Bat Relay Short Circuit	<p>The battery relay keeps close.</p> <ul style="list-style-type: none"> • Disconnect PV, grid and battery, then reconnect. • Or seek help from us, if not go back to normal state.
Bat Buck Fault	<p>The battery buck circuit mosfet is fail.</p> <ul style="list-style-type: none"> • Disconnect PV, grid and battery, then reconnect. • Or seek help from us, if not go back to normal state.
Bat Boost Fault	<p>The battery boost circuit mosfet is fail.</p> <ul style="list-style-type: none"> • Disconnect PV, grid and battery, then reconnect. • Or seek help from us, if not go back to normal state.

Eps Relay Fault	<p>The eps relay is failed.</p> <ul style="list-style-type: none"> • Disconnect PV, grid and battery, then reconnect. • Or seek help from us, if not go back to normal state.
BatCon Dir Fault	<p>The battery connection is reversed.</p> <ul style="list-style-type: none"> • Check if the positive pole and negative pole of battery are correctly connected. • Or seek help from us.
Main Relay Open	<p>The grid relay keeps open.</p> <ul style="list-style-type: none"> • Disconnect PV, grid and battery, then reconnect. • Or seek help from us, if not go back to normal state.
S1 Close Fault	<p>The grid relay S1 keep close.</p> <ul style="list-style-type: none"> • Disconnect PV, grid and battery, then reconnect. • Or seek help from us, if not go back to normal state.
S2 Close Fault	<p>The grid relay S2 keep close.</p> <ul style="list-style-type: none"> • Disconnect PV, grid and battery, then reconnect. • Or seek help from us, if not go back to normal state.
M1 Close Fault	<p>The grid relay M1 keep close.</p> <ul style="list-style-type: none"> • Disconnect PV, grid and battery, then reconnect. • Or seek help from us, if not go back to normal state.
M2 Close Fault	<p>The grid relay M2 keep close.</p> <ul style="list-style-type: none"> • Disconnect PV, grid and battery, then reconnect. • Or seek help from us, if not go back to normal state.
GridV Cons Fault	<p>The grid voltage sample value between master and slave is not consistent.</p> <ul style="list-style-type: none"> • Disconnect PV, grid and battery, then reconnect. • Or seek help from us, if not go back to normal state.
GridF Cons Fault	<p>The grid frequency sample value between master and slave is not consistent.</p> <ul style="list-style-type: none"> • Disconnect PV, grid and battery, then reconnect. • Or seek help from us, if not go back to normal state.
Dci Cons Fault	<p>The dci sample value between master and slave is not consistent.</p> <ul style="list-style-type: none"> • Disconnect PV, grid and battery, then reconnect. • Or seek help from us, if not go back to normal state.
Rc Cons Fault	<p>The residual current sample value between master and slave is not consistent.</p> <ul style="list-style-type: none"> • Disconnect PV, grid and battery, then reconnect. • Or seek help from us, if not go back to normal state.
RDSP SPI Fault	<p>The communication between master and slave is fail.</p> <ul style="list-style-type: none"> • Disconnect PV, grid and battery, then reconnect. • Or seek help from us, if not go back to normal state.
RDSP Smpl Fault	<p>The slave sample detection circuit is failed.</p> <ul style="list-style-type: none"> • Disconnect PV, grid and battery, then reconnect. • Or seek help from us, if not go back to normal state.

ARM EEPROM Fault	The manager eeprom is fault. <ul style="list-style-type: none"> • Disconnect PV, grid and battery, then reconnect. • Or seek help from us, if not go back to normal state.
Meter Lost Fault	The communication between meter and Inverter is interrupted. <ul style="list-style-type: none"> • Check if the communication cable between meter and Inverter is correctly and well connected.

BMS State

Example of non-quick fault identification:

BS1 E03: EXT COM (communication fault with PCS) and INT COM (internal communication fault)



bit: b6 b5 b4 b3 b2 b1 b0
0 0 0 0 0 1 1

BMS State	Quick Identification	bit (b0 - b7)	Fault Description
BS1	E01	b0	Communication fault with PCS (EXT COM)
	E02	b1	Internal communication fault (INT COM)
	E04	b2	Over voltage fault (OV)
	E08	b3	Under voltage fault (UV)
	E10	b4	Charge over current (OCC)
	E20	b5	Discharge over current (OCD)
	E40	b6	Over temperature fault (OT)
	E80	b7	Under temperature (UT)
BS2	E01	b0	Cell imbalance alarm (CB)
	E02	b1	Hardware Protect
	E04	b2	Reserve
	E08	b3	BMS Other Fault
	E10	b4	Voltage Sensor Fault
	E20	b5	Temperature Sensor Fault
	E40	b6	Current Sensor Fault
	E80	b7	Relay Fault
BS3	E01	b0	Inconsistent cell capacity fault (BMS_Typc_Unmatch)
	E02	b1	Reserve

	E04	b2	Reserve
	E08	b3	Reserve
	E10	b4	Reserve
	E20	b5	Unanswered charging request (BMS_MR_Unmatch)
	E40	b6	Reserve
	E80	b7	Reserve
BS4	E01	b0	Reserve
	E02	b1	Reserve
	E04	b2	Reserve
	E08	b3	Reserve
	E10	b4	Pre-charge fault
	E20	b5	Reserve
	E40	b6	Reserve
	E80	b7	Reserve
BS5	E01	b0	Relay drive circuit failure (Actor_Fault)
	E02	b1	SOH_LOW
	E04	b2	Reserve
	E08	b3	Reserve
	E10	b4	Single cell "0V" fault (SUV)
	E20	b5	Extreme overvoltage fault (CellVolt R&H Invalid)
	E40	b6	Cell Temperature High Invalid
	E80	b7	Balance Temperature High
BS6	E01	b0	Precharge resistor overtemperature (PreChg_Restemperature High)
	E02	b1	Hardware overcurrent fault (short_current)
	E04	b2	AFE Communication Fault
	E08	b3	AFE Fault (AFE UT/OT/UV/OV)
	E10	b4	IVU Communication fault
	E20	b5	Reserve

	E40	b6	Module addressing fault
	E80	b7	Reserve

10.2 Troubleshooting and Routine Maintenance

• Troubleshooting

a. Please check the fault message on the System Control Panel or the fault code on the unit information panel. If a message is displayed, record it before doing anything further.

b. Attempt the solution indicated in the table above.

c. If your inverter information panel is not displaying a fault light, check the following to make sure that the current state of the installation allows for proper operation of the unit:

- (1) Is the unit located in a clean, dry, adequately ventilated place?
- (2) Have the DC input breakers opened?
- (3) Are the cables adequately sized?
- (4) Are the input and output connections and wiring in good condition?
- (5) Are the configurations settings correct for your particular installation?
- (6) Are the display panel and the communications cable properly connected and undamaged?

Contact Customer Service for further assistance. Please be prepared to describe details of your system installation and provide the model and serial number of the unit.

• Safety check

A safety check should be performed at least every 12 months by a qualified technician who has adequate training, knowledge and practical experience to perform these tests. The data should be recorded in an equipment log. If the device does not function properly or fails any of the tests, the device has to be repaired. For safety check details, please refer to Chapter 2 of this manual.

• Maintenance checking list

During operation of the unit, the responsible personnel shall examine and maintain the device regularly. The required actions are as follows:

- Check that if the cooling fins at the rear of the units are collecting dust, and the unit should be cleaned when necessary. This work should be conducted periodically.
- Check that if the indicators of the unit are in normal state, check if the display of the unit is normal. These checks should be performed at least every 12 months.
- Check if the input and output wires are damaged or aged. This check should be performed at least every 12 months.
- Get the panels of the unit cleaned and their security checked at least every 6 months.
- Regularly check whether the service environment of the unit meets the requirements, and the installation position should be far away from the heat source.
- The unit should be stored in an environment with a temperature range between 0°C ~ +35°C, and charged regularly according to the table below with no more than 0.5 C (A C-rate is a measure of the rate at which a battery is discharged relative to its maximum capacity) to the SOC of 50% after a long time of storage.

Storage environment temperature	Relative humidity of the storage environment	Storage time	SOC
Below -20°C	/	Not allowed	/
-20~0°C	10%~90%	≤ 1 month	20%≤SOC≤50%
0~35°C	10%~90%	≤ 6 months	20%≤SOC≤50%
35~55°C	10%~90%	≤ 1 month	20%≤SOC≤50%
Above 55°C	/	Not allowed	/

*If the unit is stored over one year, 5% - 8% of the capacity will lose irreversibly.

- Regularly check whether the unit and its supporting terminals, connecting cables and indicator lights are normal.

Note: Only qualified individuals may perform the works mentioned above.

• **Storage with Low SOC**

After power-down, internal module quiescent current and battery self-discharge may gradually deplete energy reserves. To prevent potential over-discharge damage, please:

- recharge the battery promptly;
- avoid prolonged storage at low State of Charge (SOC).

Storage in low SOC may occur in the following scenarios:

- After using the System Black Start (off-grid mode), the DC Switch is not turned off.
- The batteries cannot be charged due to a system fault after discharge.
- The batteries cannot be charged due to incorrect configurations in the system.
- The batteries cannot be charged due to no PV input or long-term mains failure.

Under all conditions, batteries must be recharged within the maximum allowable period corresponding to the SOC at the time of power disconnect. Failure to recharge within the specified duration may cause damage due to over-discharge.

Storage environment temperature	Power-Off SOC before storage	Maximum charge interval
0~35°C	0% ≤ SOC < 5%	7 days

Note: If the battery SOC drops to 0%, it must be recharged within seven days. Permanent battery failures resulting from delayed charging due to customer-related causes are not covered under warranty.

11. Decommissioning

11.1 Dismantling

- Disconnect the unit from DC input and AC output. Wait for 5 minutes for the unit to fully de-energize.
- Disconnect communication and optional connection wiring. Remove the unit from the bracket.
- Remove the bracket if necessary.

11.2 Packaging

If possible, please pack the unit with the original packaging. If it is no longer available, you can also use an equivalent box that meets the following requirements.

- Suitable for loads more than 130 kg.
- Contains a handle.
- Can be fully closed.

11.3 Storage and Transportation

Store the unit in dry place where ambient temperatures are always between 0°C ~ 35°C. Take care of the unit during the storage and transportation; keep less than 4 cartons in one stack. When the unit or other related components need to be disposed of, please ensure it is carried out according to local waste handling regulations. Please be sure to deliver any unit that needs to be disposed from sites that are appropriate for the disposal in accordance with local regulations.

Exclusion

The warranty shall not cover defects caused by normal wear and tear, inadequate maintenance, handling, storage, faulty repair, modifications to the unit by a third party other than Fox ESS or Fox ESS agent, failure to observe the product specifications provided herein, or improper use or installation, including but not limited to the following:

- Damage during transport or storage.
- Incorrect installation or maintenance of the system.
- Use of the system in inappropriate environments.
- Improper, inadequate, or incorrect charge, discharge, or production circuits other than stipulated herein.
- Incorrect or inappropriate use of the unit.
- Insufficient ventilation.
- Ignoring applicable safety warnings and instructions.
- Altering or attempting repairs by unauthorized personnel.
- Force majeure events (e.g. lightning, storms, floods, fires, earthquakes, etc.).

No warranties, implied or express, exist beyond those stated herein. Fox ESS shall not be liable for any consequential or indirect damages arising from or related to the all-in-one unit or the product specifications.

Hereby, FOXESS CO., LTD. declares that the radio equipment type EVO 10 /EVO 5 is in compliance with Directive 2014/53/EU. The full text of the EU declaration of conformity is available at the following internet address: <https://www.fox-ess.com/>.

The copyright of this manual belongs to FOXESS CO., LTD. Any corporation or individual should not plagiarize, partially or fully copy (including software, etc.), and no reproduction or distribution of it in any form or by any means is permitted. All rights reserved.

FOXESS CO., LTD.

Add: No.939, Jinhai Third Road, New Airport Industry Area, Longwan District,
Wenzhou, Zhejiang, China

Tel: 0510- 68092998

Web: WWW.FOX-ESS.COM